



**Insulated Render and Cladding Association**

# Best Practice Guide External Wall Insulation

**INCA** Insulated Render and Cladding Association



## External Wall Insulation Best Practice Guide

This guide is issued by INCA to give general guidance on best practice. INCA and the organisations responsible for its content do not accept any liability arising in any way from relying on this guide. If you require advice on a specific issue, you should seek your own independent professional advice.

This guide is to be referred to in conjunction with advice, accreditations, specifications, data sheets and details from the relevant system designers.

It should be noted that each system has its variations, therefore detail information contained in this document is of a general nature.

Requests to use any part of this guide should be made in writing to:

Insulated Render and Cladding Association  
email: [info@inca-ltd.org.uk](mailto:info@inca-ltd.org.uk)

## Endorsements

This guide has been endorsed by the European Association for External Thermal Insulation Composite Systems (EAE).



## Acknowledgments

This guidance has been produced by the INCA Technical Committee. INCA would like to thank the following contributors:

Alsecco	Kingspan Insulation	Rockwool
Alumasc	Knauf Insulation	S and B EPS
Astley Facades	Knauf UK	SPSenviowall
Dryvit	Mapei UK	Sto
Ejot UK	MIB Facades	Weber
Insuletics	Parex	Wemico Building Products
Jablite	PPG Architectural Coatings	Wetherby Building Systems
JUB Systems	Rawplug	

# Contents

1	<b>Introduction</b>	4
2	<b>Statutory Bodies</b> 2.1 Planning Permission 2.2 Building Regulations	5
3	<b>EWI System Types Overview</b>	6
4	<b>System Components</b> 4.1 Insulation 4.2 Mechanical Anchors / Fixings 4.3 Adhesive Renders 4.4 Reinforcement Basecoats and Reinforcement Mesh / Lath 4.5 Finishes 4.6 Beads, Trims and Flashings	7
5	<b>Insulation Materials</b> 5.1 Expanded Polystyrene (EPS) - White and Grey / Enhanced 5.2 Phenolic 5.3 Polyisocyanurate (PIR) 5.4 Mineral (Stone) Wool / Glass Wool 5.5 Cork 5.6 Wood Fibre Insulation 5.7 Extruded Polystyrene (XPS)	12
6	<b>System Accreditations and Approvals</b> 6.1 European Co-operation for Accreditation (EA) 6.2 National Accreditation Bodies 6.3 Certification / Approval Bodies 6.4 Certification and Approvals 6.5 BBA / UKAS Accredited Approved Installer Scheme	17
7	<b>System Installation</b> 7.1 Pre-works Inspections 7.2 Cleaning and Priming / Pre-treatment of the Substrate 7.3 Checking Existing Rendered Finishes 7.4 Pull-out Testing of Mechanical Anchors 7.5 Pull-off Tests for Adhesive Fixed Systems 7.6 Working Sequences 7.7 Bonding / Fixing Insulation 7.8 Base Coat Application 7.9 Meshes 7.10 Finishes 7.11 Beads and Trims 7.12 Sealants and Junctions	19
8	<b>Evaluation of Completed Installations</b> 8.1 Inspecting Finished Systems 8.2 Acceptable Tolerances 8.3 British Standards 8.4 Using Installed Systems	26
9	<b>Detail Drawings</b>	29
10	<b>Summary</b>	61
11	<b>References</b>	62

# 1. Introduction

The Insulated Render and Cladding Association (INCA) is the recognised trade association for the external wall insulation (EWI) industry in the UK, representing the major system designers, a nationwide network of specialist installers and component suppliers. INCA also represents the industry at a European level as the UK member of the European Association for External Thermal Insulation Composite Systems (EAE).

External Thermal Insulation Composite Systems (ETICS), also referred to as EWI (External Wall Insulation) or SWI (Solid Wall Insulation) systems, have been used in the UK for over five decades. In line with the UK's commitment to reduce carbon emissions, the use of EWI systems has increased significantly in the last 5 to 10 years.

INCA is unrivalled when it comes to providing EWI experience and INCA members apply the latest skills, innovations and techniques to deliver high quality new build and refurbishment projects in the non-residential and domestic sectors. INCA has established a wide ranging body of technical, installation and component information to promote industry best practice and raise quality standards.

This document aims to outline best practice for clients, installers, main contractors, designers and architects so that EWI systems are fit for purpose and installed to a high quality standard to reduce the risk of failure. This document sets out an accepted minimum standard for all installations, looks to standardise many details that occur on site, and provides useful information on the components that contribute to a finished system.

The objective of this guide is to ensure:

- that works undertaken are of a quality that will enable the EWI system to provide a thermal upgrade, be aesthetically pleasing, and last for the design life that it has been assessed to achieve
- that the industry's clients, including architects, contractors and local authorities, are well informed to enable the correct choice of system so that every project whatever the size is delivered to the right standard
- planning, systems and products, design and detailing and installations are of high quality and to highlight the importance of the whole system concept.

EWI systems are a key measure in improving the thermal performance of buildings but they are only as good as the planning, systems and products, design and detailing and installation. It should be noted that this document sets out a minimum standard and system designers, contractors and suppliers are encouraged to exceed this standard by adding further improvements to details where appropriate.

It is important that all of the project stakeholders work in a holistic manner to examine the costs and benefits of each EWI detail. Budget constraints or access restrictions may preclude replacement of windows / doors, cladding of stepped gables and extension of roofs etc. however it is important to note that if the thermal envelope is upgraded with areas left as cold bridges this may lead to issues of localised surface condensation and also reduction in the effectiveness of the applied insulation. Following the review of the details the client should always be aware of the implications of not adopting the best practice and can therefore make a judgement on how best to proceed.

NB: This document will refer to System Designer, which can also be referred to as System Supplier. The System Designer is the 'designer of the system' and should not be confused with being the project designer.

## 2. Statutory Bodies

### 2.1 Planning Permission

The criteria for Planning Permission set out on the Government's Planning Portal indicates that for external walls:

*'You do not need to apply for planning permission for repairs, maintenance or minor improvements, such as painting your house.*

*If you live in a listed building, you will need listed building consent for any significant works whether internal or external.*

*If you live in a Conservation Area, National Park, Area of Outstanding Natural Beauty or the Broads, you will need to apply for planning permission before cladding the outside of your house with stone, artificial stone, pebble dash, render, timber, plastic or tiles.*

*Outside these areas, cladding may be carried out without having to first apply for planning permission provided the materials are of a similar appearance to those used in the construction of the house.'*<sup>1</sup>

It is recommended that the Local Authority Planning Office is contacted to ascertain if there is a need to apply for planning permission. For larger schemes, the Housing Association should be able to provide advice if a Planning Application has been submitted and granted.

### 2.2 Building Regulations

Information on Building Regulations applications is also contained on the Planning Portal and again advice should be sought from the Local Authority, however general advice is as follows:

*'If you want to re-render or replace timber cladding to external walls, building regulations may apply depending on the extent of the work.*

*Where 25 per cent or more of an external wall is re-rendered, re-clad, re-plastered or re-lined internally or where 25 per cent or more of the external leaf of a wall is rebuilt, the regulations would normally apply and the thermal insulation would normally have to be improved.'*<sup>1</sup>

---

<sup>1</sup> [www.planningportal.gov.uk/permission/commonprojects/externalwalls](http://www.planningportal.gov.uk/permission/commonprojects/externalwalls)

# 3. EWI System Type Overview

## 3 EWI System Type Overview

The image below provides an overview of the components used in all EWI systems. Each system can vary, therefore the system designer should be consulted to determine the build up and sequence for the components relevant to their system.

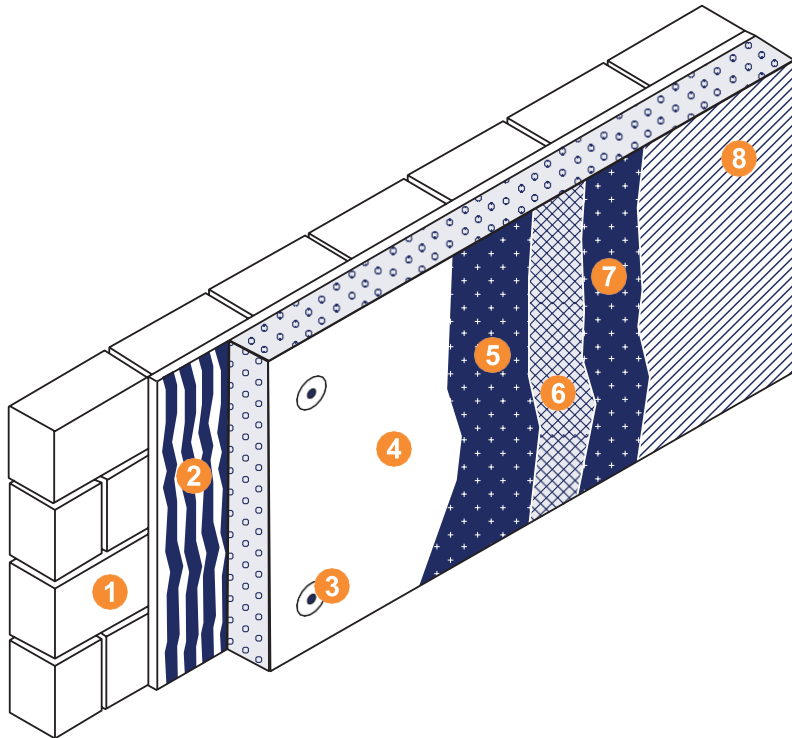

- 1 Substrate
- 2 Adhesive - if applicable to system
- 3 Fixing through insulation - alternatively fixing through the mesh
- 4 Insulation board
- 5 Base coat
- 6 Embedded mesh
- 7 Base coat
- 8 Final finish

# 4. System Components

Each EWI system comprises of a number of components which are common throughout the sector, but are carefully selected to complete system compatibility.

INCA supports the system loyalty approach and this is considered best practice. Each component should be supplied by the system designer, to the project specification. This ensures that only products tested and approved by statutory test centres and accreditation bodies are used, and that safeguards are in place throughout the supply chain and for the general performance of the system.

Components required for each system can generally be found listed on either the system designer's specification, price list or system accreditation documents.

Each EWI system will consist of the following components:

- Insulation
- Mechanical Anchors / Fixings
- Adhesive Renders
- Reinforcement Basecoats and Reinforcement Mesh / Lath
  - Polymer Modified Cement Basecoat renders, or Organic non-cementitious basecoats
  - Polypropylene / Glass fibre mesh, metal lath
- Primers
- Surface finishes
- Beads, trims and flashings.

The list above is a generic list of components so always refer to the system designer specification and Accreditation for the system build up.

## 4.1 Insulation

The insulation forms the main thermal layer as well as being the background for applying the basecoat and finishes to.

Various types and thicknesses are available (see section 5), with the choice being dependant on the required thermal performance, zoning, location and cost.

Boards are fixed either directly with adhesive, with mechanical anchors, or a combination of both.

The system designer should provide existing and proposed U-value (thermal) calculations to verify that the chosen insulation will meet Building Regulation requirements.

## 4.2 Mechanical Anchors / Fixings

Mechanical anchors form a key element of most EWI systems. Fixings are specified to suit the existing substrate, the height and shape of the building, its location and elevation, and proximity to other buildings.

Fixings should be specified by the system designer, and calculations made to check the pull-out value of the specified fixings. All mechanical anchor suppliers will provide printed literature with characteristic pull-out values and these can be used to specify the fixings, however best practice would be to check the site pull-out value and carry out wind and fixing analysis calculations based on these findings against localised conditions. This is the approved method to ensure the correct fixings and quantity are used.

## 4. System Components

It is then critical that the correct specified quantity and pattern of fixings is used on site. When using dubbing or levelling coats, care should be taken to ensure that the minimum embedment depth of the fixing is maintained. In some cases a longer fixing may be required. Fixings should be of an approved type, and should have a minimum washer diameter of 60mm. For more information please refer to *'INCA Technical Paper - A Guide to Wind and Fixing Calculations'*<sup>2</sup>.

### 4.3 Adhesive Renders

Adhesive renders are used in conjunction with adhesively fixed systems or as a supplementary adhesive to mechanically fixed systems. Adhesive renders are applied to the rear of the board in either a dot and dab method, with the perimeter of the board being coated, or with a serrated edge trowel to the entire back area of the insulation board.

### 4.4 Reinforcement Basecoats and Reinforcement Mesh / Lath

Most basecoats used for refurbishment works to insulation boards are polymer modified cement based renders, and have been formulated to be thinner than standard sand and cement renders, whilst achieving an acceptable bond strength to the insulation boards, which is proven by testing.

These basecoats are weatherproof and can accommodate varying degrees of thermal movement, however it is still recommended that movement joints are also allowed for.

Thicknesses vary dependant on the system designer however general guidance would be 6mm overall as a minimum, which is built up in two layers with the first layer reinforced with a glass fibre mesh, or mesh cloth.

In some circumstances the polymer modified cement renders can be substituted for lime-based renders, however this is uncommon. If a lime-based render is required, then it is recommended that the system designer be contacted for further advice.

Reinforcement basecoats vary considerably across the market for EWI systems. Reinforcement basecoats are used to carry a mesh or reinforcement lath over the top of the insulation layer. The reinforcement layer can be used to enhance weatherproofing, provide impact resistance to the system and spread all stresses across the façade surface into the insulation below.

There are three common types of reinforcement layers:

Thick coat traditional renders with metal lath reinforcement:

- Traditional form for structural reinforcement
- Typically 20mm-30mm thickness
- Fixings generally fixed through the lath
- Offers superior impact resistance to thin coat cement renders
- Skilled fitting required due to sharp metal lath
- Thick coat render enables accommodation of more surface undulation in insulation boards
- Requires water and mixing.

Thin coat polymer cement render with glass fibre mesh:

- Many systems in the UK use this method
- Typically 6mm-10mm thickness, although organic basecoats vary
- Polymers used to improve strength and provide more effective stress transfer into mesh and insulation
- Many reinforcement mortars are often the adhesive as well
- Mesh easier to handle than metal lath
- Requires water and mixing.

<sup>2</sup> [www.inca-ltd.org.uk/documents/INCA Technical Guide 03 Wind Load Design Considerations for EWI Systems.pdf](http://www.inca-ltd.org.uk/documents/INCA%20Technical%20Guide%2003%20Wind%20Load%20Design%20Considerations%20for%20EWI%20Systems.pdf)



## 4. System Components

Thin coat polymer render with glass fibre mesh:

- Supplied ready mixed in pails
- Typically 3mm-6mm thickness, although some system basecoats are less than 6mm. Check with system designer accreditation certificates
- Flexible and highly impact resistant
- Can be tinted for through coloured system
- To keep thickness lower substrate must be flat (EPS rasped)
- Air-dried so needs protection in winter period (low temperature grades available).

It should be noted that higher levels of impact resistance can be achieved with higher density meshes, additional mesh layers or using non-cement based basecoats.

### 4.5 Finishes

The surface finish chosen provides added weather proofing properties, but ultimately the final aesthetic look of the building.

There are many finish types:

- Acrylic textures
- Silicone textures
- Dry dash
- Wet dash
- Mineral renders
- Brick effect renders
- Acrylic brick slips
- Real brick slips.

Each system designer will have its own range of material types and effects and each finish provides a different look, however each will have specific criteria on application, location and height.

This document considers three types of binders for finishes:

- Acrylic finishes (organic or synthetic)
- Silicone resin finishes (organic or synthetic)
- Cement, lime or silicate finishes (mineralic).

Each material has different qualities and the table on the next page indicates the material properties to assist in the correct choice relevant to each application. It is the responsibility of the system designer to provide the correct finish for each application by means of a product specification.

## 4. System Components

Properties \ Binder	Lime	Cement	Silicate	Acrylic Resin	Silicone Resin
Adhesion	✓	✓	✓✓	✓✓✓	✓✓✓
Water Repellency			✓	✓✓	✓✓✓
Vapour Permeability	✓✓✓	✓✓✓	✓✓✓	✓	✓✓
Crack Resistance			✓	✓✓✓	✓✓
Weather Protection	✓	✓	✓✓	✓✓✓	✓✓✓
Durability	✓	✓	✓✓	✓✓✓	✓✓✓
Algae Resistance	✓		✓	✓✓	✓✓✓
Cost	£	£	£££	££	££££

NB: The table above should be read in general terms, as some manufacturers will provide cementitious mortars with hydrophobic qualities and additives to promote similar qualities to those of synthetic renders.

There are many different finish options available for use with EWI systems. Some of the common types are set out below.

### 4.5.1 Textured / Rilled thin coat finishes (1mm – 6mm)

These are generally available with acrylic, silicone resin, silicate or cement binders. They are tinted and generally consist of aggregate in a white or coloured binder. Either applied with a stainless trowel or sprayed, they can be applied in large areas although all textured finishes must be hand finished using a flexible plastic float. As the binders can vary between organic (synthetic) or mineralic, the properties of the finish material also vary greatly with changing formulation. The most common size of texture specified tends to be 1.5mm-2mm as this is the smallest surface grain that can start to disguise the hand applied nature of the basecoats in poor lighting conditions. Mineralic versions of this type of product are normally recommended for over painting.

### 4.5.2 Dry dash finish (6mm – 8mm plus aggregate)

These are available with mineralic (cement) binders, and acrylic or silicone resin materials. A dash receiver provides a through coloured render as a substrate for applying a dash aggregate finish, both available in a wide range of colours and sizes. The resulting finish is very good in exposed environments as it can effectively deflect and drain wind driven rain. It is also a very durable finish that discourages human contact and is impact resistant. Rough aggregate finishes can also be provided with clear acrylic polymer binders containing crushed decorative aggregates.

### 4.5.3 Scratched render finishes (6mm – 10mm)

These are available with mineralic (cement / lime) binders. They offer a colour effect in mostly pastel shades with a dressed stone appearance. This finish is resistant to small impacts and scuffs as it is through coloured. Some finishes form the reinforcement coating for reduced coating time.

## 4. System Components

### 4.6 Beads, Trims and Flashings

All EWI systems require the use of beads and trims. These will be dependant on the design and particular project. In general terms the beads and trims form the junctions and closers to the system, therefore it is imperative that these are both specified and installed correctly.

Most beads and trims are available in UPVC, aluminium, galvanised or stainless steel and can also be polyester powder coated.

Key junctions such as starter tracks should always be present and elevations with large expansive areas of EWI should allow for movement joints or expansion beads. These beads should be in accordance with system designer guidance or replication where present in substrate.

Detailing of window reveals should indicate if a stop bead is required. Sills and flashings should be installed so that they provide sufficient overhang to shed water away from the face of the finished system. Best practice is to allow for a minimum of 40mm overhang to the throat or drip. For more information please refer to 'BS13914:1:2005'<sup>3</sup>.

Detailing of these elements is critical, and if a detail occurs on site that requires bespoke-designed trims the installer should contact the system designer for advice.

In coastal locations, due to the increased airborne salts, it is recommended that stainless steel starter tracks are used, and exposed beads are either stainless steel or PVCu. Each system designer should be contacted to provide guidance for coastal applications.

Other bespoke systems are available, such as insulated fascia trims, fence post brackets, satellite dish box brackets, hanging basket brackets, washing line brackets, however these additional items should be discussed with the client / owner, and costs adjusted.

---

<sup>3</sup>BS EN 13914-1:2005 Part 1: External Renderings

# 5. Insulation Materials

There are various insulation materials available, each with their own installation requirements, K-values and compositions:

- White expanded polystyrene
- Grey (Enhanced) expanded polystyrene
- Phenolic
- Polyisocyanurate (PIR)
- Mineral (Stone) wool / glass wool
- Cork
- Wood fibre insulation.

## 5.1 Expanded Polystyrene (EPS) - White and Grey (Enhanced)

### Product Description

Expanded Polystyrene (EPS) is a lightweight, rigid, plastic foam insulation material. It is a cost-effective, easy-to-use insulation for EWI applications. As the structure of EPS consists of 98% air, its initial thermal properties are maintained throughout its working life. It is non-toxic, moisture resistant and rot proof.

### Products Available

EPS is supplied in standard white material and an enhanced thermal performance (low lambda) material which is in most cases grey in colour. A wide range of thicknesses are available to achieve the thermal values required.

### Suitability

- Low rise applications up to 18m
- High Rise application if BR135 classification achieved
- Coastal locations.

### Handling and Storage

- Easy to cut using a fine tooth saw or hot wire cutter
- 100% recyclable
- Durable, not affected by short exposure to UV or rain. Long term exposure can cause slight discolouration, but does not affect the thermal performance
- Should be stored in original packaging, on a flat, covered protected surface
- Should be kept away from solvents
- Should not be exposed to naked flame.

### Specifics

- EPS is classed as combustible, however combustibility is limited due to retardants present
- Has a high K-value when compared with other insulations
- The use of a fine tooth saw or hot knife is recommended to reduce the creation of loose material
- The surface can be 'rasped' on site to remove level differences on boards.

## 5. Insulation Materials

### 5.2 Phenolic

#### Product Description

Phenolic foam is a closed cell insulation with very good lambda values, which makes it the most thermally efficient insulation on the market. The cells are formed by the evaporation of a high-performance blowing agent, which has negligible global-warming potential and zero ozone depletion potential, leading to a better thermal value than other insulations. It is easy to use, and has good fire resistance properties, although is not classed as non-combustible.

#### Products available

A wide range of thicknesses are available to achieve the thermal values required.

#### Suitability

- Low rise applications up to 18m
- High Rise application if BR135 classification achieved
- Coastal locations.

#### Handling and Storage

- Easy to cut using a fine tooth saw
- Recycling scheme available
- Should be stored in original packaging, on a flat, covered, protected surface
- Should be kept dry
- Should not be exposed to naked flame.

#### Specifics

- Phenolic is classed as combustible, however combustibility is limited due to retardants present
- Offers the best K-value of all the insulations available, meaning thinner boards required
- Manufacturers guidance should be followed for correct application
- Should not be left exposed for long periods of time to direct sunlight and rain
- Should not be used if effected by rain until it has been dried out and assessed as being fit for purpose.

### 5.3 Polyisocyanurate (PIR)

#### Product Description

PIR foam is a closed cell insulation, with good lambda values. The cells are formed by the evaporation of a high-performance blowing agent, which has negligible global-warming potential and zero ozone depletion potential, leading to a better thermal value than other insulations. It is easy to use, and has good fire resistance properties, although is not classed as non-combustible.

#### Products available

A wide range of thicknesses are available to achieve the thermal values required.

#### Suitability

- Low rise applications
- High rise applications in conjunction with BR135 classification
- Coastal locations.

## 5. Insulation Materials

### Handling and Storage

- Easy to cut using a fine tooth saw
- Recyclable
- Should be stored in original packaging, on a flat, covered, protected surface
- Should be kept dry
- Should not be exposed to naked flame.

### Specifics

- PIR is classed as combustible, however combustibility is limited due to retardants present
- Offers good K-values, meaning thin boards required
- Manufacturers guidance should be followed for correct application
- Should not be left exposed for long periods of time to direct sunlight and rain
- Should not be used if effected by rain until it has been dried out and assessed as being fit for purpose.

### 5.4 Mineral (Stone) Wool / Glass Wool

#### Product Description

Mineral (stone) wool or glass fibre insulation is manufactured from molten rock or silica sand heated and blown to form thin fibres with binders and oils to produce an insulation with good thermal properties, but excellent fire resistant properties, and is classed as on-combustible.

It is easy to use, and is the only insulation to be classed as non-combustible.

#### Products available

A wide range of thicknesses are available to achieve the thermal values required.

#### Suitability

- Low rise applications
- High rise applications
- Coastal locations.

#### Handling and Storage

- Easy to cut using a fine tooth saw
- Recyclable
- Should be stored in original packaging, on a flat, covered, protected surface
- Should be kept dry.

#### Specifics

- Mineral wool is classed as non-combustible, giving it superior fire resistant properties
- Offers good K-values
- Manufacturers guidance should be followed for correct application
- Should not be left exposed for long periods of time to rain
- Should not be used if effected by rain until it has been dried out and assessed as being fit for purpose
- It is recommended by the manufacturer to limit the area of application of the boards and to basecoat at the earliest chance to avoid the boards becoming wet
- Boards have water repellent properties and can resist the ingress of water to the face.

## 5. Insulation Materials

### 5.5 Cork

#### Product Description

Cork insulation is a relatively new insulation to the EWI market. It is 100% natural with a cellular structure which makes it a natural insulator. Cork has natural fire inhibitors making it fire-retardant but is classed as combustible. Cork also has a good thermal value.

#### Products available

A wide range of thicknesses are available to achieve the thermal values required.

#### Suitability

- Low rise applications
- High rise applications in conjunction with BR135 classification
- Coastal locations.

#### Handling and Storage

- Easy to cut using a fine tooth saw
- Recyclable and renewable
- Biodiverse
- Durable, mould resistant and non-toxic
- Lightweight
- Rot proof
- Should be stored in original packaging, on a flat, covered, protected surface
- Should be kept dry.

#### Specifics

- Cork has natural fire retardant properties but is classed as combustible
- Offers good K-values
- Manufacturers guidance should be followed for correct application
- Boards have water repellent properties and can resist the ingress of water to the face
- A+ rating in the Green Guide to Specification.

### 5.6 Wood Fibre Insulation

#### Product Description

Wood fibre insulation is manufactured from wood chippings and natural binders. It is both vapour permeable and hygroscopic. It is easy to use, and gives good lambda values.

#### Products available

A wide range of thicknesses are available to achieve the required thermal values.

#### Suitability

- Low rise applications
- Coastal locations.

## 5. Insulation Materials

### Handling and Storage

- Easy to cut using a fine tooth saw, circular saw or reciprocating saw
- Recyclable and compostable
- Should be stored on a flat covered protected surface
- Whilst in storage the boards should be stored flat, kept dry and protected from damage
- If the boards get wet, they must be allowed to dry prior to applying the render.

### Specifics

- Vapour permeable and hygroscopic
- Good thermal mass properties, so heat is stored and then released as the temperature drops
- Manufactured from a natural and sustainable material, which locks up CO<sub>2</sub>
- Manufacturer's guidance should be followed for correct application.

### 5.7 Extruded Polystyrene (XPS)

XPS is an closed cell extruded polystyrene insulation, with good thermal and water resisting properties, whilst having a high compressive strength. A wide range of thicknesses are available to achieve the thermal values required.

### Suitability

- Low rise applications up to 18m
- High Rise application if BR135 classification achieved
- Coastal locations
- Below ground applications.

### Handling and Storage

- Easy to cut using a fine tooth saw or hot wire cutter
- 100% recyclable
- Durable, not affected by short exposure to UV or rain
- Should be stored in original packaging, on a flat, covered protected surface
- Should be kept away from solvents
- Should not be exposed to naked flame.

### Specifics

- XPS is classed as combustible, however combustibility is limited due to retardants present
- Has a high K-value when compared with other insulations
- Can react to PVC cables and cause cables to become brittle, therefore a conduit should be used.



# 6. System Accreditations and Approvals

It is considered best practice that all EWI systems are covered by a recognised certification and accreditation, such as:

- British Board of Agrément (BBA) Certificate
- European Technical Approval (ETA) Certificate
- Local Authority Building Control (LABC) Approval.

## 6.1 European Co-operation for Accreditation (EA)

As the official guardian of the European accreditation infrastructure, EA has the overall strategic objective to safeguard the value and credibility of accredited conformity assessment services delivered by its members and accredited conformity assessment bodies within the European market. Scottish Regulation 8 0.8.2 best defines EA as the umbrella organisation for all National Accreditation bodies in Europe.

## 6.2 National Accreditation Bodies

The National Accreditation body for the UK is the United Kingdom Accreditation Service (UKAS), for Germany it is the Deutsche Akkreditierungsstelle GmbH (DAkkS), for Ireland the Irish National Accreditation Board (INAB) and for the Netherlands Raad voor Accreditatie (RvA).

## 6.3 Certification / Approval Bodies

For the UK the certification body for EWI with rendering to 'ETAG 004 – Guideline for European Technical Approval' is the British Board of Agrément (BBA). For Germany it is the Deutsches Institute für Bautechnik (DIBt), for Ireland it is the National Standards Authority Ireland (NSAI) and for the Netherlands it is IKOB BKB.

These approval bodies are members of the European Organisation for Technical Assessment (EOTA) and also the European Union for Technical Approval (UEAtc).

## 6.4 Certification and Approvals

Each member can certify a product or a system not only to its own national standards / regulations but also European Technical Assessments. European Technical Approval Guidelines (ETAGs) were used as the basis for European Technical Approvals. As of 1 July 2013 no further ETAGs will be developed, however ETAGs remain valid and can be used as a European Assessment Document (EAD).

Following the Construction Products Regulations (EU/305/2011), from 1 July 2013 European Assessment Documents became recognized as a harmonized technical specification. The EAD is the basis for the issuing of European Technical Assessments.

The European Technical Assessment provides a basis for CE marking of construction products enabling the product to be placed anywhere in the EU market. Whilst separate standards exist in relation to Building Regulations that apply to England, Wales, Scotland and Northern Ireland, in respect of materials and workmanship, each country adopts the same methods regarding ways of establishing the fitness of materials.

For more information please refer to the following documents:

- The Building Regulations 2010 - 2013 Editions (for England and Wales)
- Regulation 7 - Materials and Workmanship
- The Scottish Regulations 8 - Durability, Workmanship and Fitness of Materials
- Northern Ireland Technical Booklet B - Materials and Workmanship.

## 6. System Accreditations and Approvals

Each country harmoniously identifies the following methods of establishing fitness of materials using the following processes, published standards and certification schemes:

- CE Marking under the Construction Products Regulation
- CE Marking under other EU Directives
- British Standards
- Other national and international technical specifications
- Independent Certification Schemes
- Tests and calculations
- Past experience
- Sampling.

### 6.5 BBA / UKAS Accredited Approved Installer Scheme

The approved installer scheme provides fully accredited, independent inspection services across the UK. Unprejudiced inspectors provide expert, unbiased information on a range of products and their installation in the construction industry.

The scheme is monitored to UKAS ISO:17020 accreditation allowing the inspection of BBA or UKAS approved installers and installers operating under client managed schemes, as well as surveillance visits carried out on behalf of the government endorsed Competent Person and TrustMark schemes<sup>4</sup>.

---

<sup>4</sup><http://www.bbacerts.co.uk/installer-approval/>

# 7. System Installation

## 7.1 Pre-Works Inspections

### Approved Installer

The Installation is to be completed by an approved installer organisation, using suitably skilled and experienced operatives. Operatives from the approved installer organisation must be trained, assessed and approved by the EWI system certificate holder / system designer.

### Site Survey, Pre Installation Survey and Preliminary Work

Survey and preparation of the building is key to obtaining a successful specification and finished installation. If this is done incorrectly the success of the EWI system and / or the existing fabric will be at risk.

To correctly specify which insulation system to use, the existing wall construction should be determined and understood, to allow an existing U-Value to be calculated.

Visiting the site is essential before works are commenced in order to survey the building and elevations that are to receive the system. This is done to determine what remedial work needs to be carried out (if required) prior to the EWI Installation starting.

Preparing the substrate in order to receive the chosen EWI system is extremely important, if the substrate is not prepared to receive the chosen system as intended then this can have severe implications on the performance and aesthetics of the system i.e. if the wall is not straight or plumb then the overall finish will not be straight or plumb as the system will follow the contour of the existing substrate. It should also be noted that render is a hand applied finish.

It is always recommended that the following is undertaken prior to the application of an EWI system:

- Check for rising damp and the causes
- Check for existing movement joints and make provision to reflect this in the new installation
- Check for efflorescence (lime bloom) or if similar problems have been treated and remedied that the masonry has dried out sufficiently
- Test the walls for any defects
- Test the existing substrate for pull out loads so that fixing type and quantities can be determined
- Carry out a line and level survey to determine if a dubbing out or levelling coat is required
- Remove moss, lichen, mould, and treat with an anti-fungicidal wash if required
- Identify any unusual detailing issues
- Determine if any architectural features need preserving or re replicating in order to be repositioned and placed within / on the new EWI system
- Evaluate access to the property, heights of the building and security of tenants
- Contact the local planning department to evaluate if planning permission is required, although recently planning permission for EWI has been relaxed still check with the planning department as this is of particular importance if the property is situated in a conservation area or area of outstanding natural beauty or if the property is listed etc.
- Contact local building control authority, unless using an installer organisation who is part of a SWI Person Scheme (CPS) who can self certify their work complies with building regulations without the need for a separate assessment by building control
- Discuss finishes, colours and textures with the client / interested parties

## 7. System Installation

- Ensure that the contractor is aware that the eaves and roof zone should have adequate insulation to avoid cold bridging at these junctions
- Evaluate the need for repositioning of or temporary removal and / or extension of services such as overhead electricity, TV, telephone and broadband connections / equipment, gas or oil pipe work, electricity or gas meters, lights, rainwater goods etc.

Once the building survey / pre installation survey has been completed, drawings and specifications for each elevation that is to receive an EWI system are to be prepared and instigated prior to the project starting.

The drawings and specification would include some or all of the following:

- Position of starter tracks and render beads
- Position and amount of reinforcement scrim, corner mesh and scrim patches for corners / corners of openings
- Detailing around doors, windows, eaves, projecting balconies, coping details and special details such as abutments, extensions (robust standard solution / typical design details are available from the system certificate holder / system designer)
- Damp proof course level
- Location and type of weather seals to be used
- Areas where silicone sealants are to be used
- Position of fire barriers (if required)
- Type of system to specify
- Location of movement joints
- Location and positioning of beads and trims
- Flashing details
- Window and door sill details
- Architectural features i.e. quoins, external corncing , stringers, keystones, window headers, window sills, window architraves , corbels, arches, flat bands, raised or recessed bands, ashlar cuts and columns etc.
- Coping details and special details such as abutments, extensions
- Attachments such as gates and fences, clothes lines and satellite dishes.

The systems should be continuous, as breaks can create cold bridging and junctions are potential weak zones for moisture ingress. The system designer should engage with the installation contractor and attend site, where possible, to undertake a project inspection on the installed system.

### Electrical Power Distribution Cables

Electrical power distribution, whether via overhead cable or siamesed from an adjacent property is often clipped to the outside face of external walls. These cables are high voltage and are unprotected by circuit breakers. They must not be touched by anyone other than the Distribution Authorities. The acceptable solution to overcome issues caused by cables fixed to walls where EWI is required is very much dependent on the local Power Distribution Authority's requirements. The first stage is therefore to agree beforehand how to work around the cables. Historically, some have simply allowed the cables to be covered. This however is less acceptable now, because of health and safety concerns. Occasionally, Power Distributors will take a pragmatic view, and use the opportunity to renew ageing cables immediately after the EWI works are undertaken; allowing them to be temporarily covered and with provision being created for new surface mounted cabling in the vicinity.

Other Power Distributors take a harder line to covering cables, even temporarily, but are happy to co-ordinate the replacement of the cables along with the EWI work. In these instances a patch is inevitably required, which is more acceptably completed with a brick or other contrasting detail.

## 7. System Installation

The costs of the cable repositioning works also depends on the approach of the Power Distributor. Older cables are often moved free of charge, but if they are not due for renewal, then a fee is generally necessary. Either way, in order to influence the Power Distributors timeframe so that it fits-in with your programme depends on the strength of your relationship with them. An early dialogue is critical to this development.

Where there is no option to relocate a cable to another position, and covering is unacceptable, the only option is to leave an uninsulated trough in which the cable runs. This trough might be covered with a plate to minimise the aesthetic appearance. Again the Power Distribution authority will advise on the acceptability and specification of the plate, e.g. whether PVCu or other non-metal product, solid or perforated, etc. For details see Section 9.

### 7.2 Cleaning and Priming / Pre-treatment of the Substrate

Before applying an EWI system, the wall should also be checked for dirt, grime, algae etc, and measures taken to clean the surface. Once cleaned with a power wash, and if required mild detergent, the wall should be allowed to fully dry out. Once dry the wall is ready to accept the EWI system, or (if specified) a primer, to allow for increased adhesion for adhesive renders.

### 7.3 Checking Existing Rendered Finishes

If a building has an existing rendered finish, guidance from the system designer should be sought. If the render is in a poor condition, then it is best practice to remove the render using a hammer drill. If areas of render are thought to be loose then these should also be hammer tested and render removed locally. Any rendered areas that have been removed, should be made good with either sand and cement or a proprietary render repair system.

Guidance should always be sought from the system designer in case the existing render is damaging the existing wall by trapping water, transmitting damp, and not allowing the existing building to breathe.

### 7.4 Pull-out Testing of Mechanical Anchors

Prior to commencing any project it is recommended that pull-out tests for the specified fixings are undertaken. On discussion with the system designer and fixing manufacturer, it may be that fixings used into a common solid wall can be accepted by way of tabulated data, however it is good practice to ensure that mechanical anchors / fixings are checked for suitability.

Pull-out tests are carried out using a Hydrajaws fixing tester to test the load or pull out value of the fixing. It is recommended that a minimum of 15 tests are carried out per project, or an acceptable spread of results for larger projects.

### 7.5 Pull-off Testing for Adhesive Fixed Systems

The purpose of the test is to measure the maximum tensile strength of the render and other overlying materials on the substrate. The test sample is subjected to increasing tensile stress until failure occurs. The weakest path could be along an interface between two layers or a cohesive failure within one layer or a combination of these.

The test method is generally seen to be conducted using a 50mm diameter plate with the adhesive render applied, to which a load measure is applied and the pull off value taken at failure.

This test should be undertaken when using adhesive only fixed systems, or a combination of adhesive with supplementary mechanical anchors.

## 7. System Installation

### 7.6 Working Sequences

It is crucial that an installer plans the working sequence in line with site requirements, resource, system specification, and weather conditions.

Checks should be made on the line and level of any existing building, and recommendations made to the client. Should it be found that if directly fixed the system will suffer due to the uneven surface of the wall, this should be noted prior to commencement of works.

The site operatives should familiarise themselves with the project specification and details prior to works commencing.

An assessment of the building should be undertaken to ensure all relevant details have been reviewed, and provided. Should there be reason for additional details, then the installer should notify the system designer for advice.

At the completion of each day's work, or whenever work is interrupted for extended periods of time, board edges and joints should be protected from inclement weather.

In addition to the normal reasons why works may be interrupted, such as weekends, public holidays, programming considerations etc. adverse weather conditions can also be a factor. Some components of EWI systems have limitations on temperatures between which they can be installed, as well as additional requirements which can involve limiting exposure to precipitation or strong sunlight (particularly in warmer climates) during installation to control rates of drying, or prevent excess moisture being trapped within the system.

Therefore, to protect un-finished systems during a break in works, or from on-going adverse weather conditions temporary weather protection may be required to protect installed components which are not fully weatherproofed.

To provide protection from exposure during extended breaks within the installation process, with regards to interruptions on site, and protection of components which are not fully weatherproofed from inclement weather.

The precise nature of this protection may vary depending on the cause of the requirement for the temporary protection (e.g. to provide shading, or to protect from precipitation), the area of system required to be protected and the expected timescale over which it would be expected to be in place, although may typically include the use of items such as opaque tarpaulin / damp proof membranes or rolls of nylon-reinforced polyethylene plastic temporarily restrained to the structure or scaffolding. In practical terms the actual protection provided will vary based upon the specific nature of the project and construction site, and responsibility in this regard should be managed by the project team in consultation with the EWI system supplier.

Base coat application should only be carried out when the weather is fine and free from rain. It is recommended to carry out a daily check on the weather forecast, for a minimum of 48 hours prior to the proposed application of wet renders.

Base cementitious render application should be in two coats and incorporate a scrim reinforcement layer between them and completed with a finishing coat. All render coats should be strictly applied in accordance with the system supplier's accreditation and their current application guidance, paying particular attention to thickness and cure times between layers.

Minimum total render thicknesses should not generally drop below 6mm. However, this advice is not intended to supersede or negate existing advice from the system certificate holders / system designers / suppliers.

Finishing coats should be applied out of direct sunlight, and shielded from direct heavy winds. This will avoid the finishes curing too quickly and potential cracking occurring.

## 7. System Installation

### 7.7 Bonding / Fixing Insulation

Boarding works should only occur in dry conditions, and boards should be protected from adverse weather, direct sunlight and possible impact damage.

Boards should be laid in a staggered pattern, and should be staggered at the edges of buildings so that they form a toothed finish.

Generally boards should be cut in an L shape around the corners of openings, and small cuts of boards should not be allowed. Minimum cuts will vary from system supplier, however it would be best practice to limit cuts to a minimum of 200mm.

Gaps in boards should be limited, and should be filled with expanding foam, or mineral wool slithers should they occur.

Boards should be level so that the basecoat and decorative finish are installed on a flat true surface. Levelling of boards can be undertaken with adhesive renders or dubbing out renders, and should be assessed at contract stage and allowed for within the contract costs.

Adhesive renders should be applied to the rear of the board, and should follow either a dot and dab method, with renders to the board edges, or a fully applied adhesive using a serrated trowel. This will be subject to the system designer's recommendations.

Mechanical anchors should be as those specified within the project specification, and comply with the system designers fixing pattern. The correct quantity of fixings should be used. Fixings should be installed at a true 90 degrees from the wall face, and the washer head sitting flush with the board face. Fixings that are seen to be installed at an angle should be assessed and may have to be discounted and additional fixings installed.

### 7.8 Base Coat Application

Base coat application should only be carried out when the weather is fine and free from rain. It is recommended to carryout a daily check on the weather forecast, for a minimum of 48 hours prior to the proposed application of system designers.

### 7.9 Meshes

The application of any mesh should occur at the first basecoat stage, when using a thin coat system. Meshes for the thick coat system are generally metal laths types and are fixed to the insulation prior to first base coat.

Polypropylene or glass fibre meshes should be installed into the wet basecoat, using the back of a steel trowel and pushed in, so that they sit in the top third. Meshes should be continuous, and should have a minimum 100mm (10cm) lap with the adjacent mesh. Any meshes that are integral to beads and trims should also allow for 100mm (10cm) lapping. This ensures strength and continuity of the basecoat.

A second basecoat is then applied, and there should be no visual sign of the mesh once this is applied.

Once the basecoat has been applied, it should be left to cure in its appropriate state to receive the final finish i.e. suitably scarified in the case of thick coat finishes or sponged for fine textures.



## 7. System Installation

### 7.10 Finishes

System designer guidance should be sought on each particular finish and the application. However, in general terms, finishes should only be applied in good weather and within ambient temperatures (5-30 degrees), although some finishes may have a winter working additive provided.

Finishes should be stored in areas that can achieve a constant temperature, and should not drop below five degrees. Acrylic and silicone textures contain water which can freeze should the temperature drop below zero degrees and damage the material for use.

Powdered finishes will have water added, therefore temperature is also key when installing powdered finishes. Should brick effect renders be applied in low temperatures, or when the weather is damp, foggy or there is excessive moisture in the air, they can suffer from efflorescence or lime bloom. This will cause a white powder on the surface of the finish, resulting from the movement of the free limes in the cement. Although efflorescence does not unduly effect the performance of the product, it can be unsightly.

Textured finishes should be applied with a steel trowel and rubbed with a plastic or nylon trowel to 'reveal' the aggregate. It is recommended that the installer should always follow a wet edge, and should finish at a stop bead or movement joint.

It is also advised that care is taken when texturing around scaffold points. It is best practice to have two operatives applying material above and below the scaffold point, and the wall rubbed up at the same time in the same direction to avoid scaffold marks. Alternatively a stop bead should be provided at scaffold level so that the finish can be applied in two separate applications, again to avoid scaffold marks.

It is best practice to split a building elevation into workable sections, by way of movement joints and stop beads. This is not always approved of by clients or designers, however to ensure a neat finish this should be recommended.

Systems can be finished with a one coat render system, which should be installed as recommended by the system designer. These one coat system are generally applied to a nominal thickness of 14mm-16mm, and then scratched back to expose the aggregate. One coat renders are also known as 'monochouche', referring to 'one coat'. Always read the installation instructions, and advice on acceptable application temperatures and weather conditions.

### 7.11 Beads and Trims

A full list of beads should be noted within the contract specification or price list. These beads should be installed as per system designer recommendations and manufacturers guidance. Beads should be fit for purpose, and installed by a competent person.

Trims at verges and eaves and soffits can be a concern, and these should be formed to ensure a good watertight seal is provided. Should there be a detail that standard trims would struggle to overcome, then it is recommended that site specific trims be allowed for and measured on site.



## 7. System Installation

### 7.12 Sealants and Junctions

Many junctions are finished with a mastic sealant, however its use should be kept to a minimum. Sealants are very versatile however they have a short life cycle and will need to be maintained and replaced at regular intervals.

Each system designer will be able to provide a repair and maintenance programme, which will identify the periodical checking and replacement of mastic seals.

The type that is recommended is a low modulus neutral cure external grade mastic, which has greater flexibility than standard high modulus silicones.

It is recommended that the mastics are checked prior to use and the correct grade used.

Best practice would be to assess each junction and provide a longer term solution to preventing water ingress. PPC trims are preferred as they will last for the life time of the system. Sealants can be used, but only where a trim cannot be used.

Silicone mastic sealants can be installed either 'within' the rendered finish or on the exposed surface. General good practice would be to apply the silicone into a prepared 5 / 6mm gap, and filling the gap with the silicone or other approved elastomeric sealant, and the final finish taken over the top. This is generally preferred when using thicker coat finishes such as dashing aggregate, brick effect render, acrylic or clay brick slips. The preferred method of sealing should be discussed with the system designer.

# 8. Evaluation of Completed Installations

## 8.1 Inspecting Finished Systems

When inspecting finished systems, there are tools available to every client, installer or system designer that can be used to determine if the finished system is to an acceptable standard.

The final aesthetics can be very subjective, therefore should the need arise 'BS EN 13914-1:2005'<sup>5</sup> provides a section on the final finished surface and how it should be reviewed for sign off.

The sections which should be reviewed and used on site are as follows.

### 8.1.1 Glancing Light Conditions

If the surface is to be inspected under glancing light conditions it should be stated in the contract specification.

### 8.1.2 Viewing Conditions

When inspecting a finished externally rendered surface, it should be viewed in daylight, standing at ground level, from a generally accessible viewing position. Where possible it should be viewed at a distance of 10m with the sunlight, if any, not falling onto the surface in a glancing condition.

It is also acknowledged that certain finishes (such as brick effect renders) can suffer from drying-out cracks or fissures, which although at times unsightly, do not have any adverse effect on the overall performance of the system.

Cracks are defined as a crack which is greater in width than 0.2mm. Any cracks larger than this size should be assessed accordingly.

It should be remembered that EWI systems and the renders and finishes are hand applied products that will have an element of tolerance.

These tolerances are indicated within the National House Building Council (NHBC) document 'A consistent approach to finishes'<sup>6</sup>, which is a good aid to assessing final tolerance.

General checks should be made at the following areas:

- At the base of a starter track, at the rear to ensure no gaps occur which vermin can access behind the system
- To the front of a starter track to ensure finish is neat and tidy
- General appearance of the texture, using the guidance above
- Tolerances using the guidance indicated in section 9.2
- Junctions at window reveals, sills and heads to ensure they are sealed correctly
- Overhang of the window sills to be min 40mm
- Junctions at eaves / soffit level, and at verge trim level to ensure jointing clips have been used and junctions are fully sealed
- Parapet level to ensure sealed correctly
- Rear of a parapet, to ensure it has the correct flashing provided
- General tidiness of the work
- Finished work against project details.

<sup>5</sup>BS EN 13914-1:2005 Part 1: External Renderings

<sup>6</sup>National House Building Council (NHBC) Technical Standards, 2011. Chapter 1.2 - A consistent approach to finishes

## 8. Evaluation of Completed Installations

### 8.2 Acceptable Tolerances

When checking accepted tolerances the following guidance should be adopted, however if a client wishes to improve on this guidance, then this should be identified within the contract documents. It should however be noted that the application of EWI and rendered finishes are generally undertaken by hand. An allowance for this should always be accepted by the end user. It would be recommended that a site retained sample panel, or pilot house be completed, and approved as a benchmark for future application. Baseline guidance can be seen below, and should be used for general assessments. Where EWI systems are being applied to domestic low rise buildings, the system will follow the line of the existing building, unless agreed in writing with the client beforehand.

#### Flatness

*'The maximum allowed vertical and horizontal deviation from flatness (excluding features) of the render in any 5m section is  $\pm 8\text{mm}$ .'*<sup>7</sup>

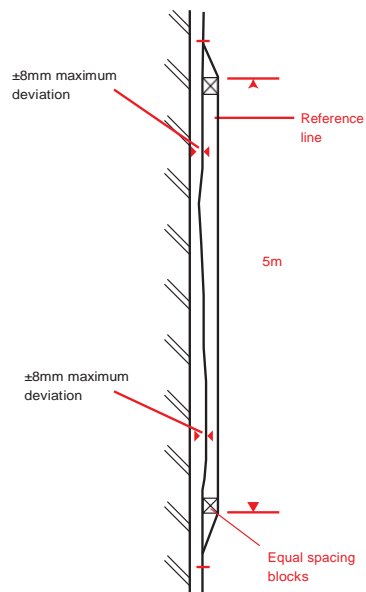

*'Areas of render in close proximity to features (e.g. bell casts) are excluded from the tolerance. Flatness is measured in a similar way to straightness on plan and plumb of masonry.'*<sup>7</sup>

$\pm 8\text{mm}$  maximum vertical and horizontal deviation from flatness

#### Appearance

*'Appearance should be considered for entire wall areas, panels, interfaces and the like and not for individual units. Consequently the wall being considered should, where possible, be viewed in daylight from a distance of not less than 10m.'*

*Rendering on walls should be reasonably consistent in texture, finish and colour. Some hairline cracking and crazing is likely to occur in both traditional and proprietary render systems. Such cracking and crazing should not impair the performance of the render. Crazing, which may occur in the render surface, should not be more than 0.2mm wide. There may be some colour variation in appearance due to differences in suction of the background and orientation of the wall. Daywork joints, patching and other repairs may be visible but should not be unduly obtrusive.'*<sup>7</sup>

<sup>7</sup> National House Building Council (NHBC) Technical Standards, 2011. Chapter 1.2 - A consistent approach to finishes

## 8. Evaluation of Completed Installations

### 8.3 British Standards

The following documents should be used for reference when preparing a contract specification, and agreeing or reviewing completed works:

- NHBC: A consistent approach to finishes
- BS EN 998-1-2010 : Specification for Rendering and Plastering Mortars
- BS EN 13914-1: 2005 Part 1: External Renderings.

### 8.4 Using Installed Systems

When using an EWI system on an existing building, it should be noted that there may be a level of residual moisture trapped within the structure through years of exposure which cannot be accounted for when calculating condensation in accordance to BS 5250 : 2011. It should also be noted that the majority of existing buildings where EWI systems are applied to are not air tight and condensation is controlled by gaps in the structure / interface with windows, etc., not through designed in ventilation such as trickle vents or mechanical ventilation. When designing a modern building that is air tight, considerations to air movement are allowed for to minimise the risk of condensation and these methods should also be considered in refurbishment schemes where there is a known problem.

Once EWI has been installed, where walls have known high exposure and there is a risk of trapped moisture or water ingress, any large items of furniture should be moved away from external walls to prevent condensation build up behind them whilst the walls dry out. The occupants of the building must also take ownership and be encouraged to engage in air movement. This can be simple education of not closing trickle vents, ensuring air changes are made by opening windows in high humidity rooms to allow trapped moisture to escape and / or ensuring mechanical ventilation is not switched off and is allowed to carry out its function.

In most cases, condensation during the initial couple of heating cycles can be addressed through simple changes of the occupants' habits.

## 9. Detail Drawings

The details in this section provide what is regarded as a baseline for best practice. These details aim to provide a consistent approach to on-site installation and aims to promote good workmanship.

Always refer to the system designer details and project specific details if the system designer wishes to further improve on these details.

The details provided are indicated with mechanical fixings and adhesive bond, all details can be used with adhesive only and mechanical only system by omitting either component.

*'The Achilles heel of any installation can be the attention to bespoke details and appropriate consultation with the system designer' – INCA Contractor Member*

### Plinth / Starter Track – Mechanically Fixed System

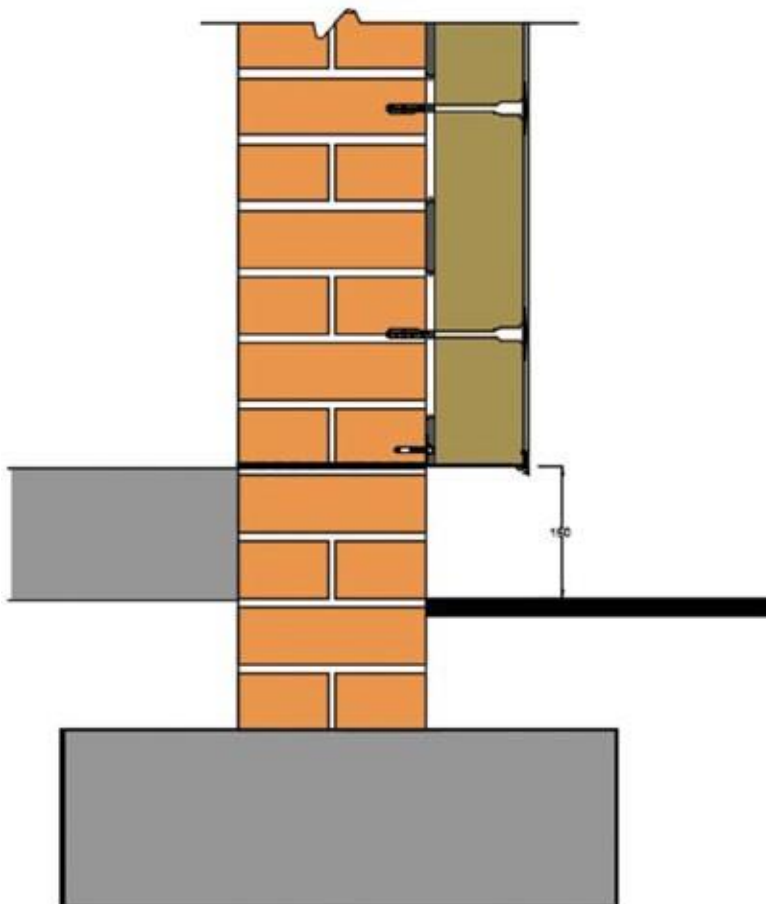

A selected insulation is either adhesively bonded, mechanically fixed or with a dual fixed system, dependent on system design.

Specified starter track should be installed at existing DPC level, with specified fixings at correct centres. Starter tracks should be installed against a flat surface, with any gaps filled with expanding foam, plastic trims, or silicone sealant, however it would be preferred to dub out the wall locally to ensure full contact with the wall and rear up stand of the trim.

Trims are set 150mm above ground level to reduce the effects of 'splash back' of rainwater, dirt and other contaminants, however it is advised that DPCs should not be bridged.

*Detail 1 – Plinth (mechanically fixed system)*

### Plinth / Starter Track – Adhesive Fix System

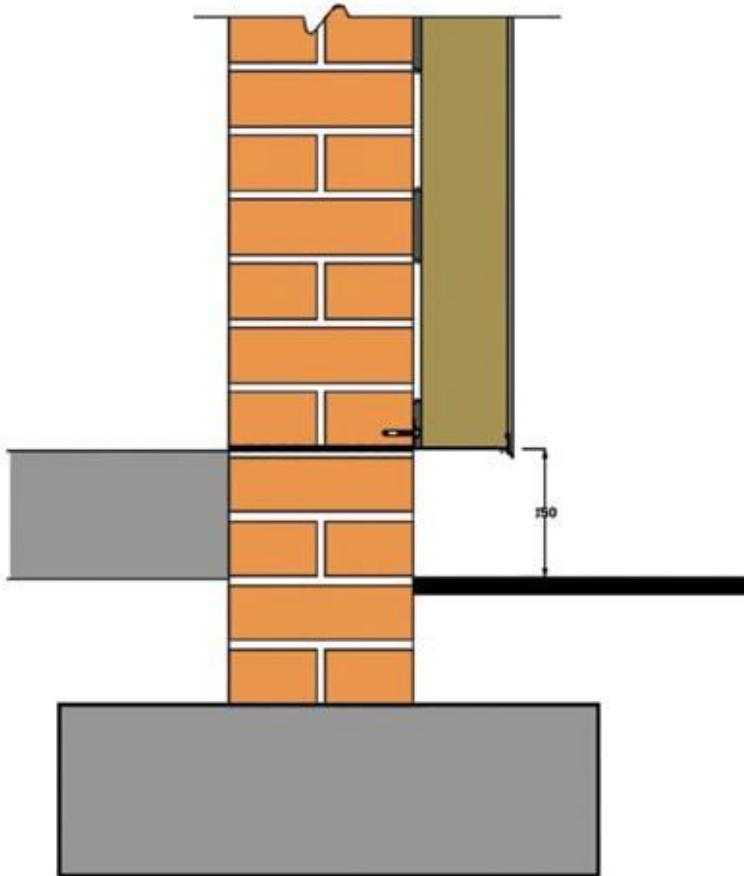

A selected insulation is either adhesively bonded, mechanically fixed or with a dual fixed system, dependant on system design.

Specified starter track should be installed at existing DPC level, with specified fixings at correct centres. Starter tracks should be installed against a flat surface, with any gaps filled with expanding foam, plastic trims, or silicone sealant, however it would be preferred to dub out the wall locally to ensure full contact with the wall and rear up stand of the trim.

Trims are set 150mm above ground level to reduce the effects of 'splash back' of rainwater, dirt and other contaminants, however it is advised that DPCs should not be bridged.

*Detail 2 – Plinth (adhesive fix system)*

### Plinth detail with Insulation Below DPC

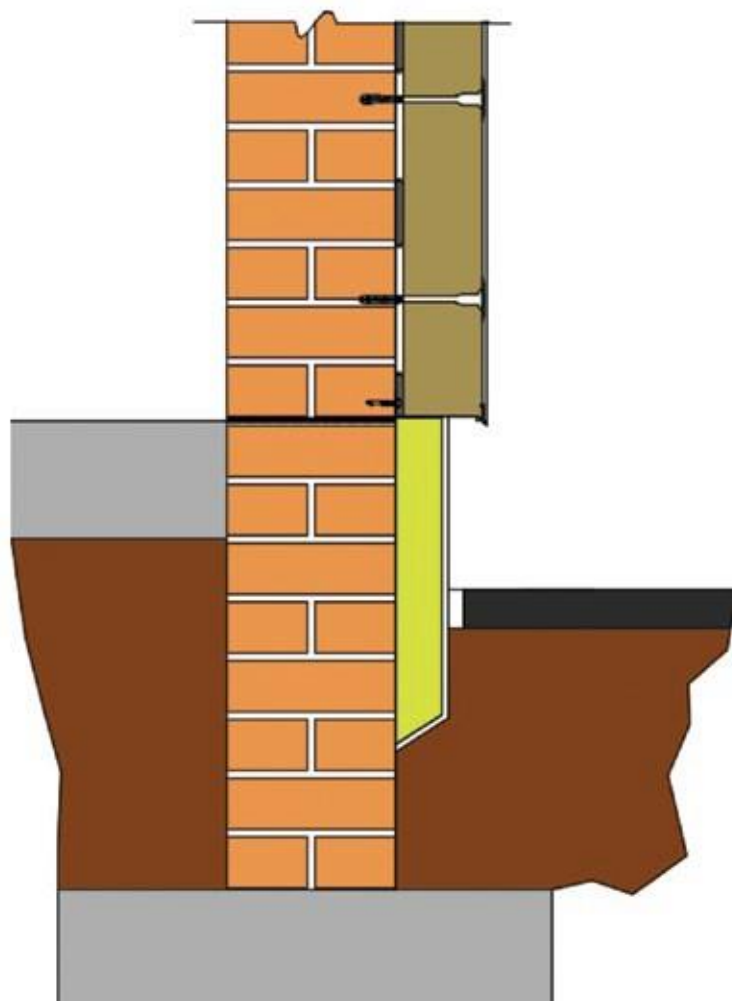

The system should be installed as previous details, and starter track installed at existing DPC level, or 150mm above ground level.

For insulation below the DPC, it is recommended that the insulation thickness is less than the main insulation, to create a step and drip between the two elements.

Insulation types should be chosen that have low moisture uptake properties, as specified by system designers for each particular project.

It is recommended that the area adjacent to the plinth is removed of any grass, or soil, and replaced with paving slabs, brick paving, stone chippings, and if the water content of the ground is high, allowance for a land drain or soak away should be considered.

*Detail 3 – Plinth detail (insulation below DPC)*

### Window Sill Details

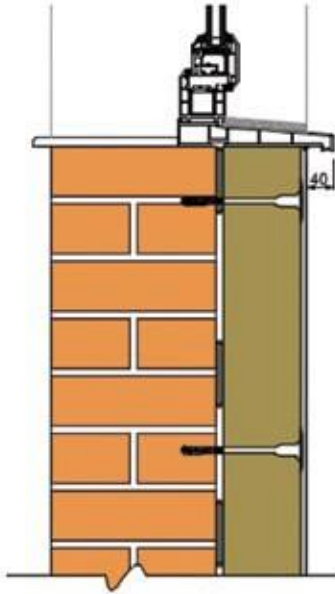

*Detail 4 - New windows with integral sill*

Should the project incorporate new replacement windows, the frames and sills should be designed to take account of the thickness of the EWI system to be applied.

Any new sills should be sized so that they allow for a min 40mm overhang to the face of the finished EWI system, and all new windows should be installed prior to the installation of the EWI system. Refer to BS13914:1:2005. It is recommended that the EWI system is taken over the edges of the sill and frame, so that the lapping provides a sound seal, silicone mastic should be applied (see reveal details).

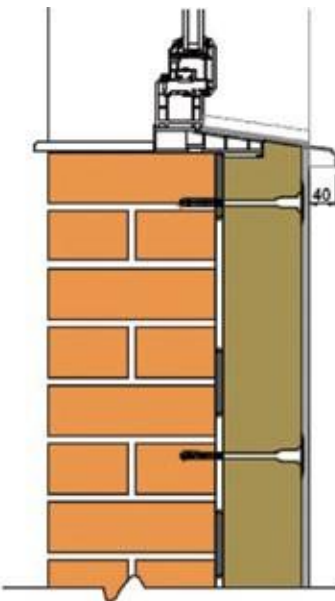

*Detail 5 - Existing windows and sills with new over sill profile*

Should the project retain the existing windows, it is generally noted that the existing sills have insufficient overhang to allow for sufficient shedding of water away from the face of the finished system.

Should this be the case, then a new over sill profile can be installed. These should be cut to suit each window, and ideally have up stand wings, to enable the render to overlap and provide a weather tight seal. The sills should be installed so that there is a minimum of 40mm over hang from the face of the finished system. Refer to BS13914:1:2005. All junctions should be finished with a silicone mastic seal (see reveal details).

**Note:**

*When installing any over sill profile, it is important to consider existing weep hole frame drainage, and the frame should be either drilled to create new weep holes, or the under sill (detail 6 ) should be used.*



## 9. Detail Drawings

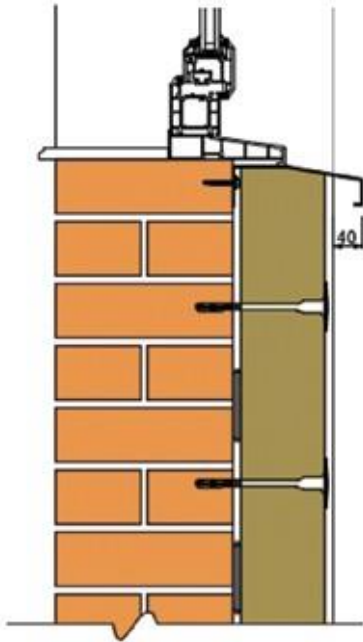

*Detail 6 - Existing windows and sills with new under sill trim*

Should the project retain the existing windows, it is generally noted that the existing sills have insufficient overhang to allow for sufficient shedding of water away from the face of the finished system.

Should this be the case, then a new under sill profile can be installed. These should be cut to suit each window, and be mechanically fixed to the substrate. There should be a minimum of 40mm overhang created from the face of the finished render and any junctions finished with silicone mastic sealant. Refer to BS13914:1:2005.

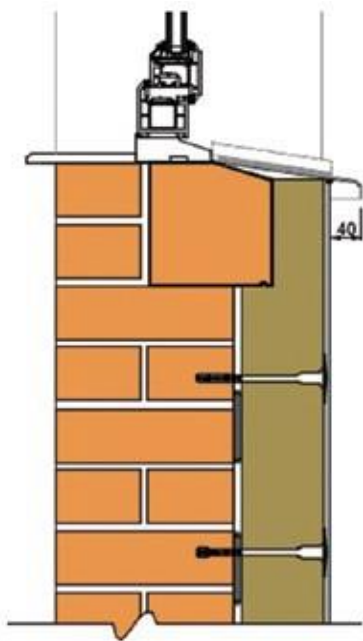

*Detail 7 - Existing feature sills with existing retained windows*

Should the project retain existing windows and there is evidence of an existing feature either of a stone sill, or brick feature, it would be recommended that a new sill be installed over the existing feature and any voids filled with expanding foam. The new insulation should be locally cut to deal with the projecting feature, or a thinner board be used.

It should be noted that these details can vary considerably on site, and there is a chance of a localised cold bridge occurring. Clients should seek further guidance from the system designer.

## 9. Detail Drawings

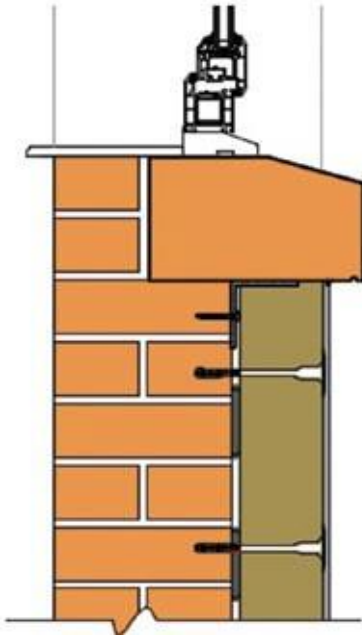

Should the planning condition indicate that there should be a replication of an existing stone sill, it should be considered how to deal with a localised cold bridge.

It may be possible that the existing stone sill be removed, or cut back and a new insulated GRP or similar 'dummy' sill be installed which will enable the reduction of a cold bridge occurring.

*Detail 8 - New feature sill*

### Window / Door Reveal Details

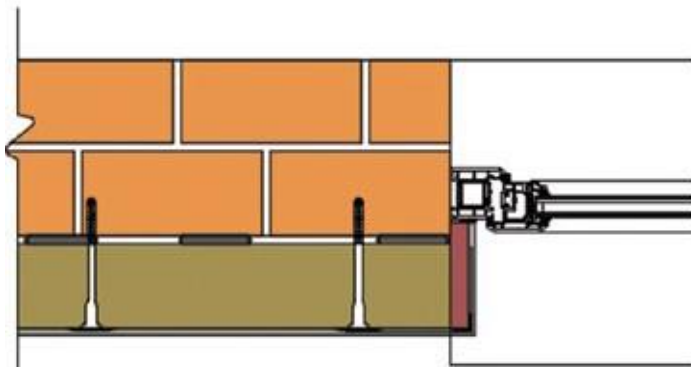

*Detail 9 - Reveal detail when window is set back from the face of the existing wall, where there is sufficient frame margin for the introduction of cold bridge insulation*

All existing reveals should be checked to ascertain the correct detail to be used. It is important that EWI systems are designed to remove any chance of a cold bridge occurring.

Frame margins should be measured and if sufficient margin, circa 50mm is found, then there should be the introduction of a minimum of 20mm high K value insulation and render. The system to frame junction should have a stop bead and silicone mastic applied, or silicone mastic to the base coat render and the top coat installed over. Stop bead and silicone mastic is the preferred detail.

## 9. Detail Drawings

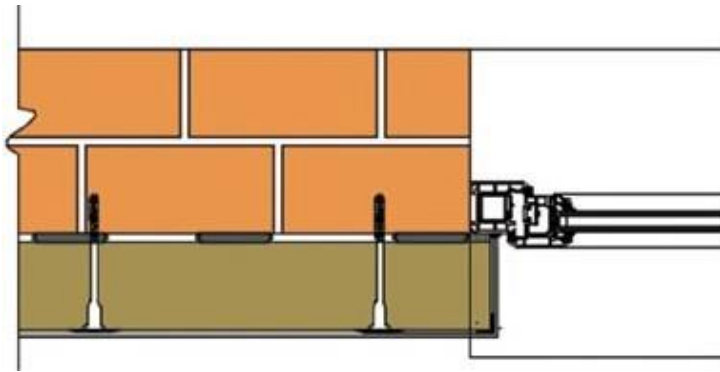

*Detail 10 - Reveal detail when existing window frame is flush with the existing wall face*

When the frames are surveyed and found to be flush with the existing face of the external wall, the insulation board should over sail the frame by min. 20mm (or to allow cover of insulation without fouling the opening sash), and the render finish returned to the frame, with the approved junction finish, being stop bead and silicone mastic or a hidden mastic applied to the base coat layer.

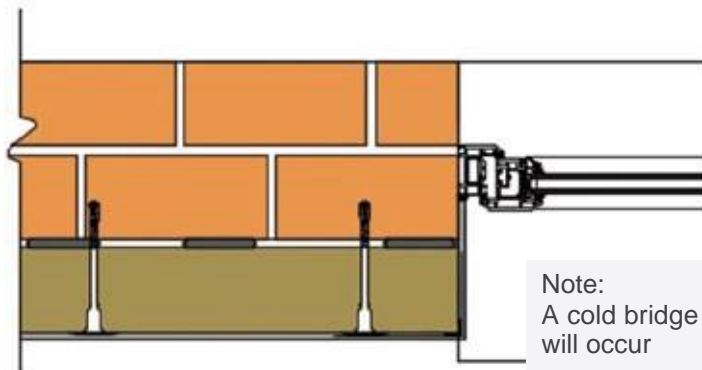

*Detail 11 - Reveal detail where existing frames are retained, however there is insufficient frame margin for cold bridge insulation*

The detail where no reveal insulation is provided is not ideal, and will cause localised cold bridging, however it is recognised that in certain circumstances it can not be avoided. Development of proprietary insulated reveal trims should be considered.

Note:  
A cold bridge  
will occur

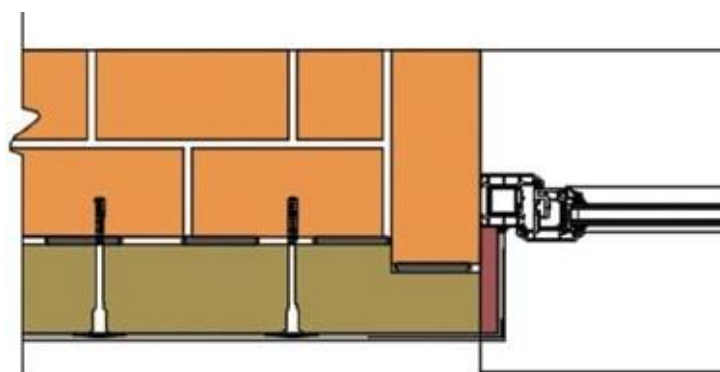

*Detail 12 - Reveal where projecting features occur*

Frame margins should be measured and if sufficient margin circa 50mm is found, then there should be the introduction of a minimum of 20mm high K value insulation and render. The system to frame junction should have a stop bead and silicone mastic applied, or silicone mastic to the base coat render and the top coat installed over. Stop bead and silicone mastic is the preferred detail. Should there be a projecting brick feature insulation boards should be cut or a thinner board be provided.

### Window / Door Head Details

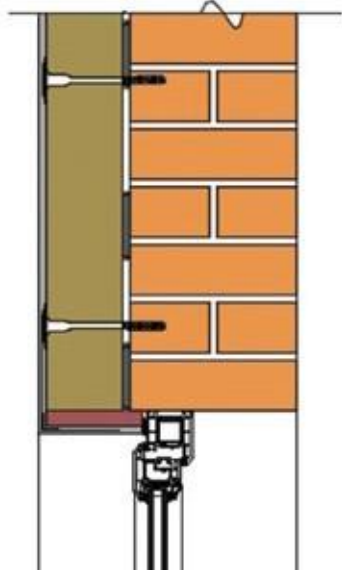

*Detail 13 - Head detail when window is set back from the face of the existing wall, where there is sufficient frame margin for the introduction of cold bridge insulation*

All existing heads should be checked to ascertain the correct detail to be used. It is important that EWI systems are designed to remove any chance of a cold bridge occurring.

Frame margins should be measured and if sufficient margin, circa 50mm is found, then there should be the introduction of a minimum of 20mm high K value insulation and render. The system to frame junction should have a stop bead and silicone mastic applied, or silicone mastic to the base coat render and the top coat installed over. Stop bead and silicone mastic is the preferred detail.

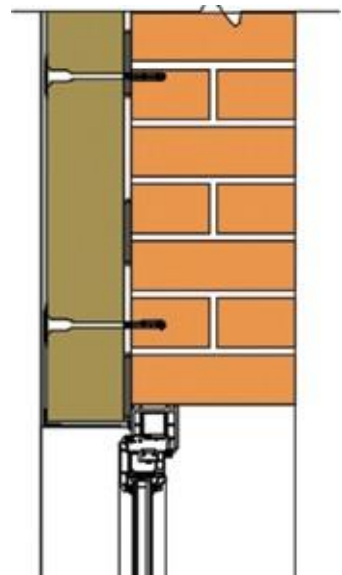

*Detail 14 - Reveal detail when existing window frame is flush with the existing wall face*

When the frames are surveyed and found to be flush with the existing face of the external wall, the insulation board should over sail the frame by min. 20mm (or to allow cover of insulation without fouling the opening sash), and the render finish returned to the frame with the approved junction finish, being stop bead and silicone mastic or a hidden mastic applied to the basecoat layer.

## 9. Detail Drawings

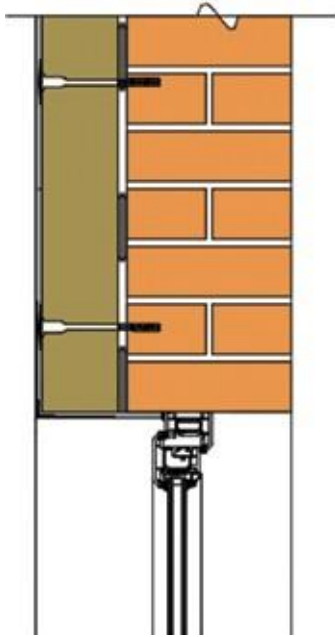

The detail where no head reveal insulation is provided is not ideal, and will cause localised cold bridging, however it is recognised that in certain circumstances it can not be avoided. Development of proprietary insulated reveal trims should be considered.

Note:  
A cold bridge  
will occur

*Detail 15 - Head detail where existing frames are retained, however there is insufficient frame margin for cold bridge insulation*

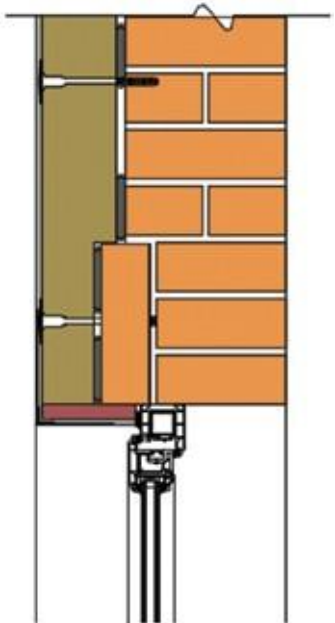

Frame margins should be measured and if sufficient margin circa 50mm is found, then there should be the introduction of a minimum of 20mm high K-value insulation and render. The system to frame junction should have a stop bead and silicone mastic applied, or silicone mastic to the base coat render and the top coat installed over. Stop bead and silicone mastic is the preferred detail. Should there be a projecting brick feature insulation boards should be cut or a thinner board be provided.

*Detail 16 - Head where projecting features occur*

### Door Base Return Detail

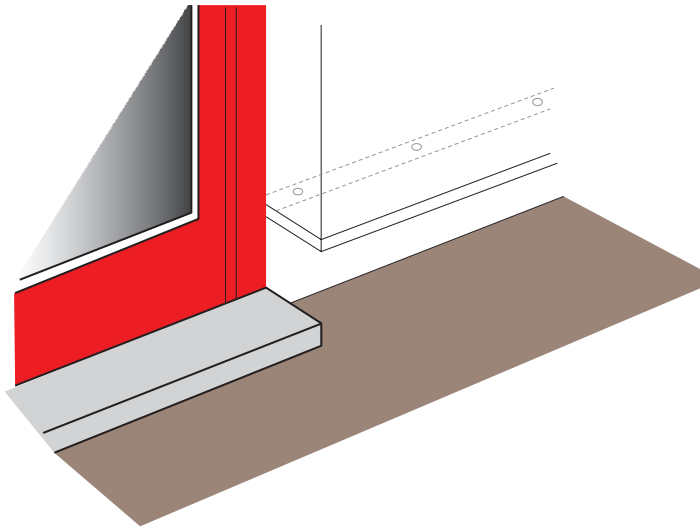

When starter tracks are installed, jointing clips and meshed nosing should be installed, and where starter tracks meet a door opening, the starter track should over sail the insulation by the depth of the reveal insulation (generally 20mm), and locally notched. A render only drip bead should be installed and taken back to the frame. This will allow for closing of the system and a neat reveal.

*Detail 17 - Starter track detail at opening junction to a door*

### Bay Window Details

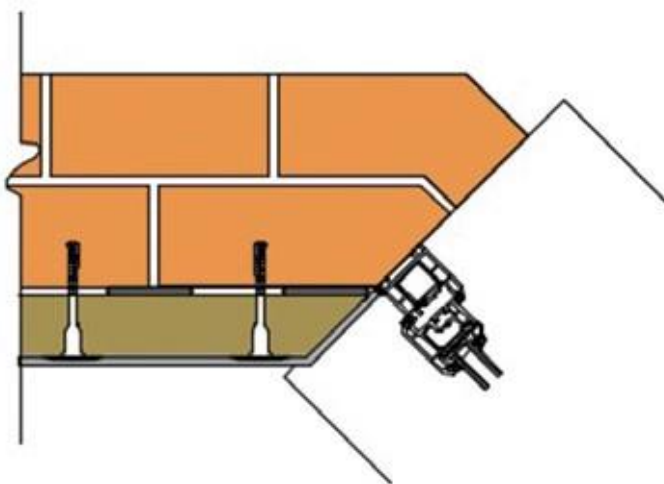

Assessment of bay windows should take place by the chosen system designer as the construction and design can vary on a project and house-to-house basis, however the principle remains that the opening sash should be allowed to open, and the reduction of a cold bridge allowed for. To ensure this occurs it is standard practice to chamfer cut the insulation to form a 90 degree angle from the window frame, and ensure the render finishes are taken over the frame and finished with the approved junction detail.

*Detail 18 - Detail where system meets an existing bay window*

## 9. Detail Drawings

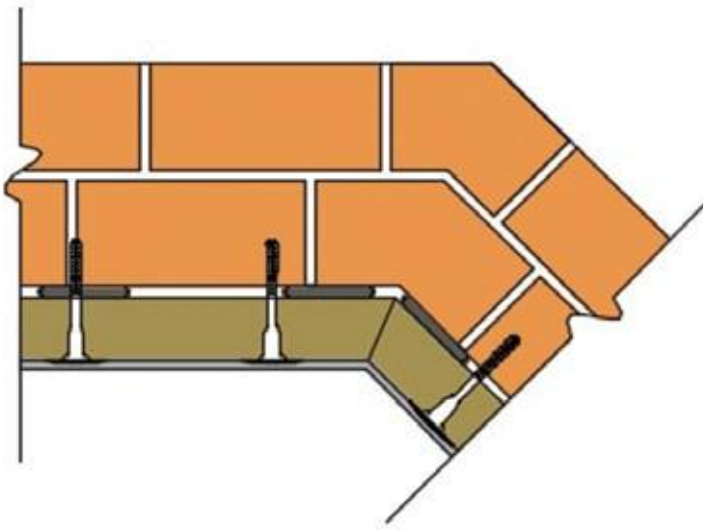

*Detail 19 - Detail at plinth of existing bay window*

When a system is installed over an existing angles wall or bay plinth, it is required that the insulation is cut at an angle to ensure a neat abutment. It is also required that the starter tracks are cut on site to form the correct angle, ensuring that the starter track base is consistent and the insulation is fully protected. Gaps may be filled with expanding foam, or slivers of mineral wool, if required.

Note:  
Roof Insulation  
should be  
provided

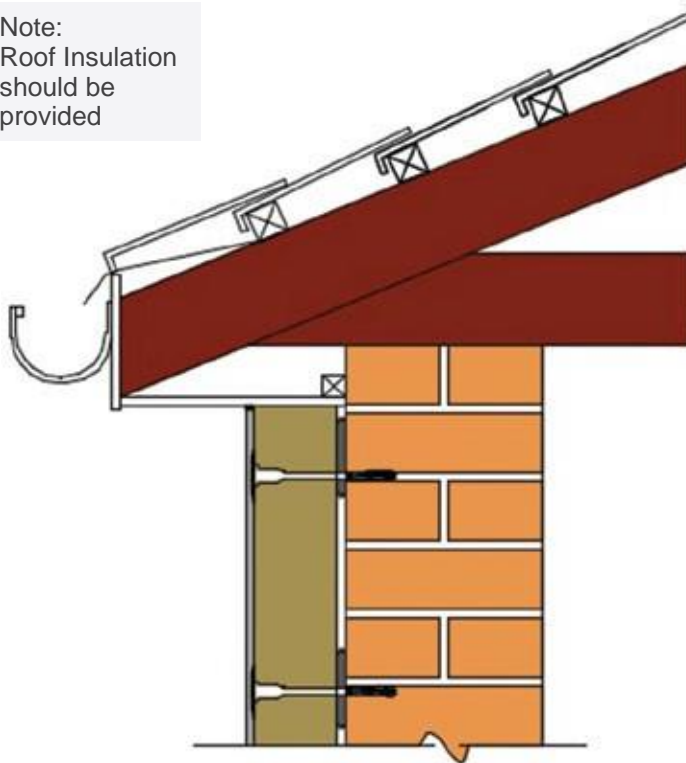

*Detail 20 - Existing overhanging soffit*

Where an existing soffit board is retained, the system should be taken tight against the underside, and a bead of silicone mastic applied.

It is imperative that the contractor / client checks to determine if there is evidence of existing insulation within the roof void that will ensure no cold bridge will occur. Failure to check this may result in localised condensation and mould growth to the top of the internal walls.



## 9. Detail Drawings

Note:  
Roof Insulation  
should be  
provided

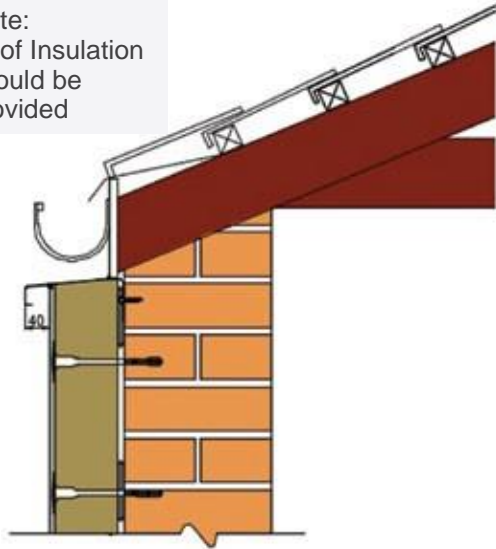

Detail 21 - Existing flush fascia

Existing flush fascia boards generally are retained. Best practice would be to remove and extend the roof line sufficiently to accommodate the new EWI system, however where this is not possible, a new trim should be installed, mechanically fixed, and sealed with silicone mastic. Trims should have a minimum of 30mm-40mm drip overhang from the face of the finished system and any joints connected with proprietary jointing clips. Joints should not be filled with silicone mastic. Insulated fascia and trim profiles are being developed and should be considered. It is also imperative to ensure insulation is evident within the existing roof zone to avoid condensation and mould growth.

Note:  
Roof Insulation  
should be  
provided

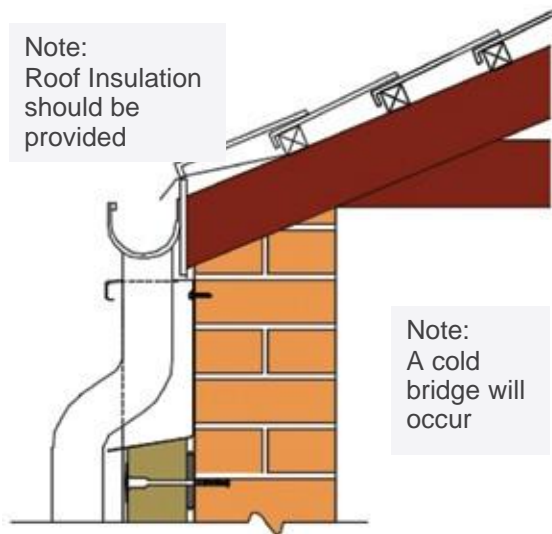

Note:  
A cold  
bridge will  
occur

Detail 22 - Detail where existing flush fascia retained and existing gutter and rainwater down pipe are retained

When the existing flush fascias are retained, the existing gutter is generally retained, with the down pipe outlet also retained. It is therefore recognised that the down pipe needs to be adjusted using a swan neck connection. Where this occurs there should be sufficient protection to the edges of the insulation and also a drip profile introduced to ensure water is directed away from the face of the finished system. Proprietary box profile systems are available and should be used, or a series of trims installed to create a sealed unit. Ideally the rear of the unit should be insulated and proprietary systems are being developed.

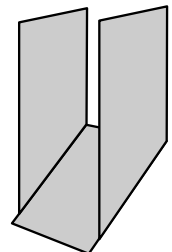
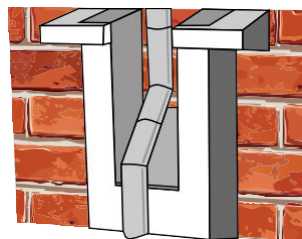



## 9. Detail Drawings

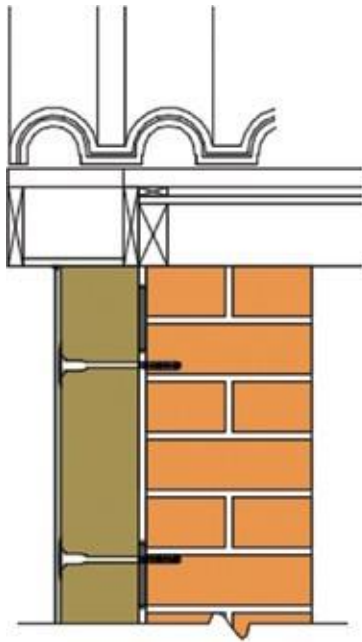

Note:  
Roof Insulation  
should be  
provided

Where the building has an existing overhanging verge, or the verge has been extended, the system should be taken tight up to the underside of the existing soffit board, and a silicone seal applied.

It is imperative that the contractor / client checks to determine if there is evidence of existing insulation within the roof void that will ensure no cold bridge will occur. Failure to check this may result in localised condensation and mould growth to the top of the internal walls.

*Detail 23 - Detail at overhanging or extended verges*

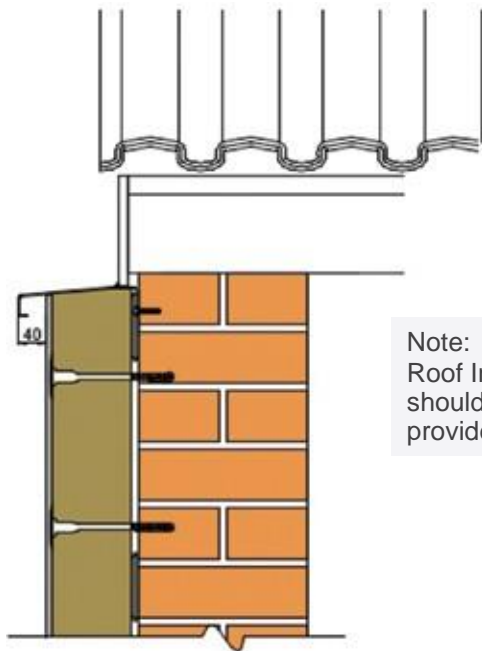

Note:  
Roof Insulation  
should be  
provided

It would be considered best practice to extend a flush finished roof verge, however where this is not possible, a new trim should be installed, mechanically fixed, and sealed with silicone mastic. Trims should have a minimum of 30-40mm drip overhang from the face of the finished system and any joints connected with proprietary jointing clips. Joints should not be filled with silicone mastic.

Insulated fascia and trim profiles are being developed and should be considered. It is also imperative to ensure insulation is evident within the existing roof zone to avoid condensation and mould growth.

*Detail 24 - Detail at flush verge*

## 9. Detail Drawings

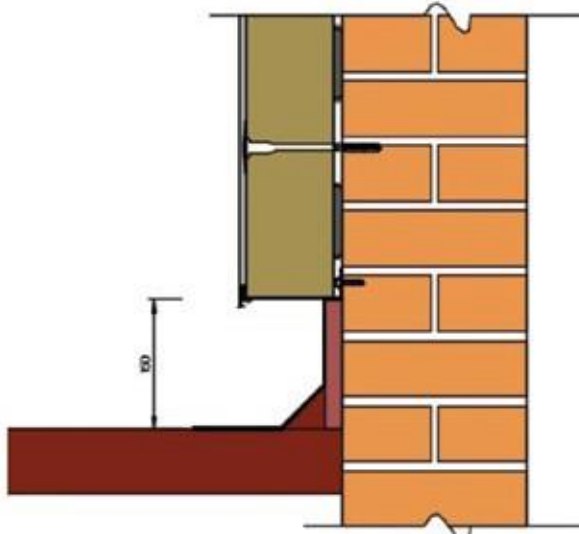

*Detail 25 - Detail over existing flat roof*

Where systems are taken over existing flat or pitched roofs, the system should be installed so that there is a minimum of 150mm above the existing finish. A 20mm high K-value insulation board installed below the starter track. A new flashing should be installed to provide 150mm up stand and 150mm laps to the roof, and adhered.

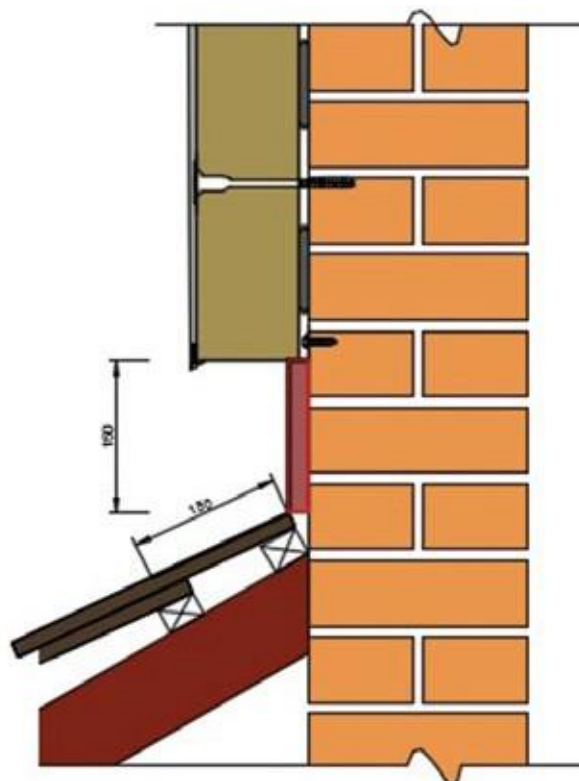

*Detail 26 - Detail over existing pitched roof*

This detail will avoid the risk of a cold bridge and potential condensation and mould growth to the internal wall.

### Fixtures and Fittings

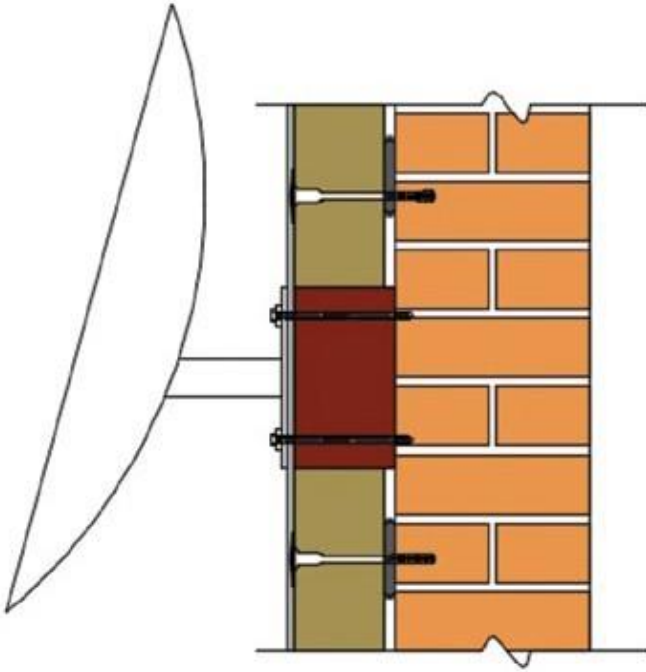

*Detail 27 - Heavy items such as satellite dishes, aerials, washing lines etc*

Any heavy weight items should be identified by the contractor and an allowance for a pattern or ground installed. The ground should be fixed using a minimum of 4 fixings to the substrate and its position marked.

The EWI system applied tight up to the ground and a double layer of mesh applied over, with the render system applied the face of the ground as part of the main system finish. The fixtures can then be fixed into the ground.

Size of the grounds is determined by the size of the item to be fixed, however it would be recommended that cover of 50mm be allowed for from the edge of the fixing of the item to be installed.

Grounds can vary in type, and the system supplier should be consulted. Treated timber or dense insulation can be used.

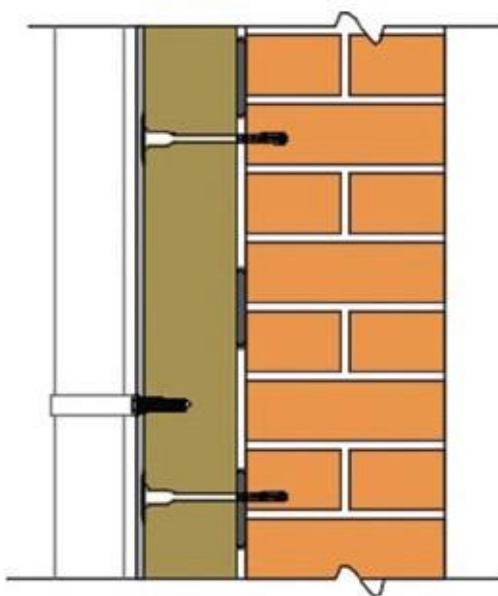

*Detail 28 - Lightweight items such as rain water pipes, lightweight signs etc*

Proprietary 'Spiral Anchor' fixings can be installed which are designed for use with a thin coat render system.

These should be installed as recommended by the system designer and the fixing manufacturer.



## 9. Detail Drawings

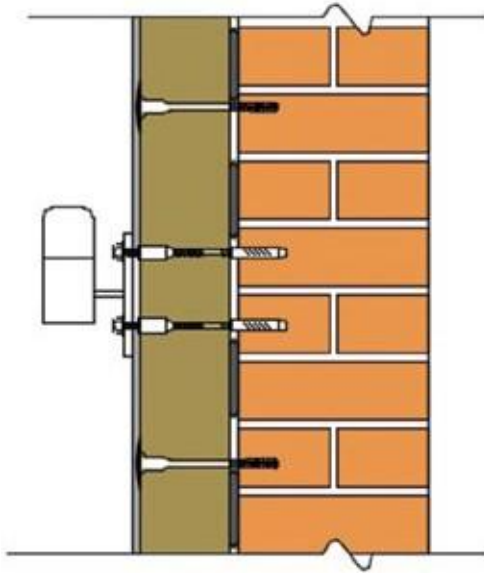

Detail 29 - For post fix items such as lights, satellite dishes, aerials etc

For post installation items, these can be installed using proprietary cantilever fixings.

The recommended allowable loads should be checked with the manufacturer prior to use, and all holes that are made through the system, should be sealed with silicone mastic sealant.

### Extending 'Live' Airbricks

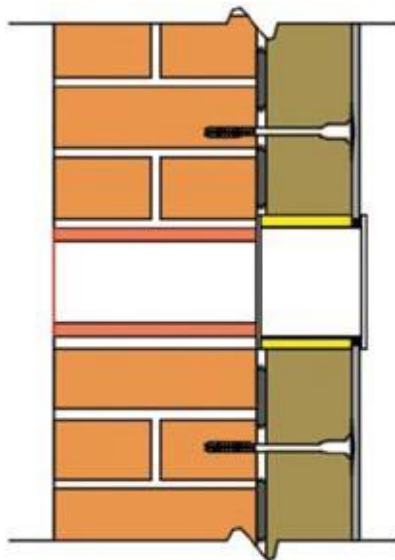

Detail 30 - Proprietary air brick extension

The client / contractor should advise if existing air bricks are 'live'. If they are to be retained, then they should be extended using a proprietary UPVC airbrick extension profiles, such as those indicated below.

All junctions should be fully sealed with silicone mastic sealant and any voids in the insulation filled with expanding foam.

The render finish should be taken tight to the sides of the unit and sealed with a silicone mastic sealant.

**Note:** It is the responsibility of the client / main contractor to identify which air bricks are in use and which can be covered.

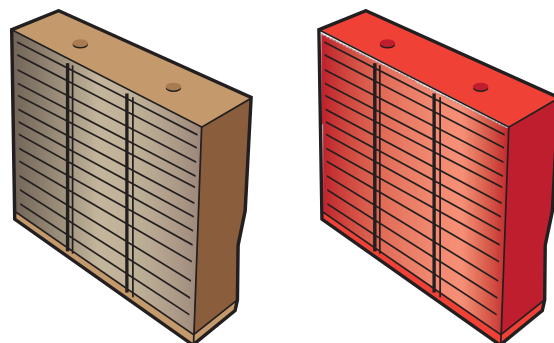

## 9. Detail Drawings

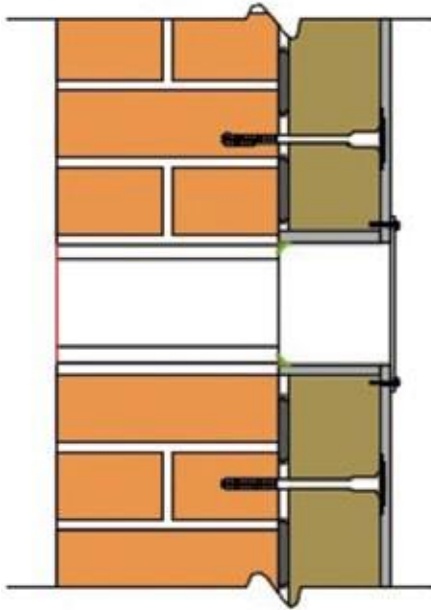

*Detail 31 - Rendered return and cover plate*

If the bespoke UPVC units are not installed, then air bricks should be maintained by allowing a hole within the insulation to the size of the existing air brick, and the render system returned into the reveals of the opening. Any returns should be sealed with a silicone mastic sealant.

To ensure rainwater does not sit within the opening, a UPVC or PPC aluminium vented cover plate should be provided, and fixed to the system using the spiral anchors and screws, and bedded on mastic.

### BT Connections

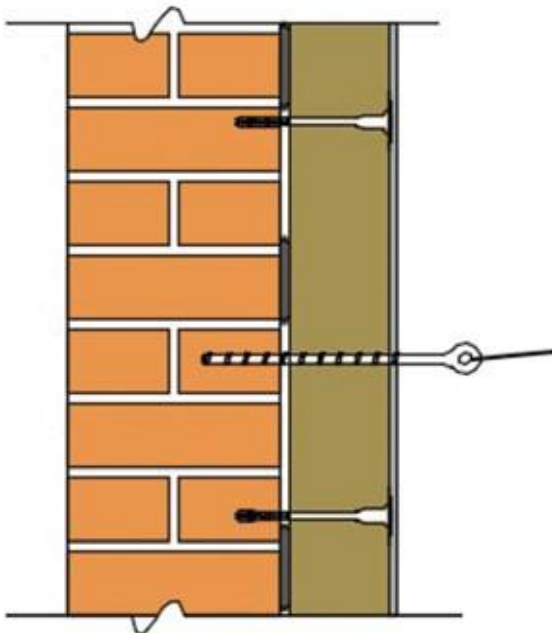

*Detail 32 – BT connection through insulation*

Extending BT brackets or covering BT wires without first contacting BT Openreach should not be undertaken.

BT Openreach have a process to ensure the safe upgrade of brackets and wires which is undertaken by approved BT Openreach engineers.

It is against the law to damage the BT Network, and may have health and safety implications.

Contact should be made with the local BT Openreach representative, prior to work commencing.

### Gas Pipes

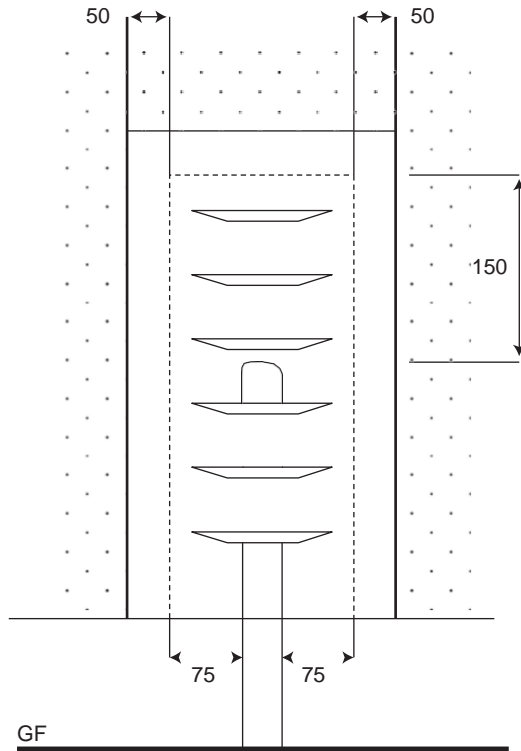

Best practice would be to move the existing gas pipe, however timescales do not always allow this.

Although there are no current regulations that cover the dimensions for dealing with existing gas pipe inlets, the dimensions indicated have been adopted as being acceptable.

It is critical that the trims used to create the void are fully sealed with a silicone mastic sealant so that no gaps are evident to allow any gas which can leak from the pipe to move behind the EWI system and build in the voids created.

To avoid the ingress of water and for aesthetics, a PPC aluminium vented cover plate should be installed fixed to the EWI system using the Spiral Anchors and screws.

Detail 33 - Elevation on gas pipe cover

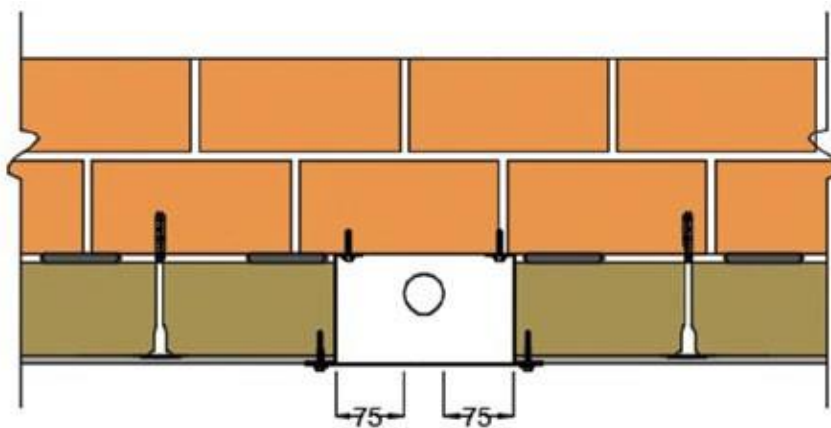

**Note:** It is the responsibility of the client / main contractor to check that the proposed detail is acceptable with the Gas supplier

Detail 34 - Plan on gas pipe

## 9. Detail Drawings

### Gas Boxes

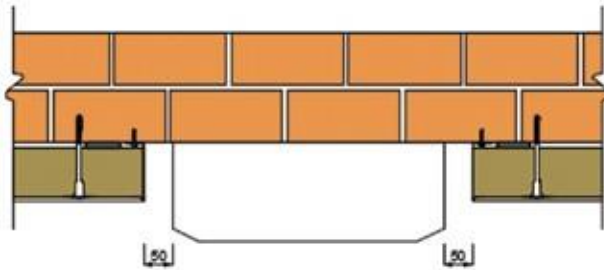

Detail 35 - Plan on existing gas box

Note: A cold bridge will occur

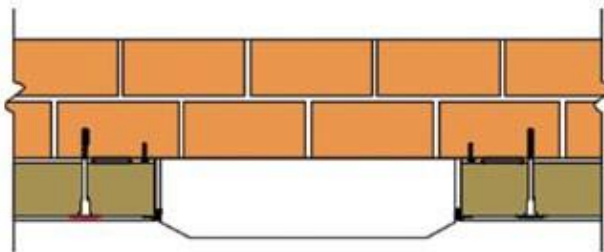

Detail 36 - Plan of existing front access panel gas box

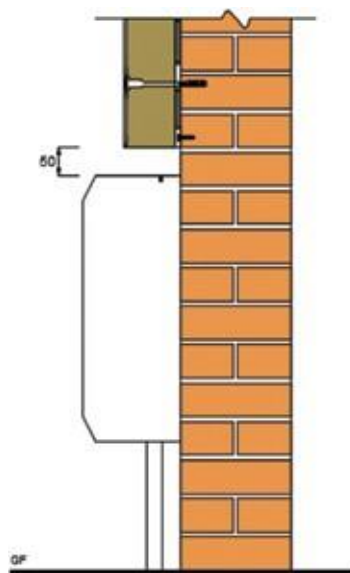

Note:  
A cold bridge will occur

Detail 37 - Section through gas box

Best practice would be to move the gas box and re-fix on a timber ground to the thickness of the new EWI system, however timescales do not always allow this.

No current regulations exist with regards to the acceptable dimensions for existing gas boxes, however there should be a review on the type of gas box existing on site.

Many gas boxes are required to be removed, so that access to the regulator valve can be provided. Access to the regulator valve using a stub screw driver or spanner can be achieved in a dimension of 50-60mm. The valve is generally lower than the box cover therefore a dimension of 50mm should be sufficient to access.

An assessment of the box and position of the regulator valve should be undertaken, and the dimension checked to ensure access can be provided.

There may be occasion where the existing gas box can be accessed and maintained from the front access panel. Therefore the system can be taken tight to the box.

Proprietary box surrounds are available and these should be used where possible.

**Note:** It is the responsibility of the client / main contractor to advise which detail is acceptable for each specific project.



## 9. Detail Drawings

### Extract Flues

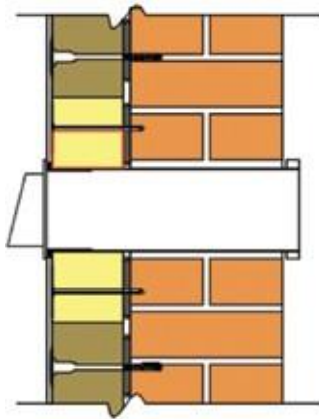

Detail 38 - Hot Extract Flue

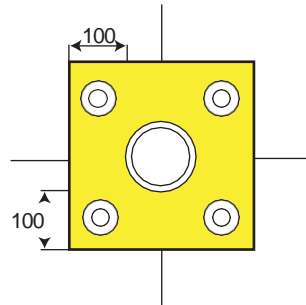

Existing hot extract flues should be extended using a proprietary extension pipe to the depth of the new EWI system. The extension pipe should be secure and fully sealed against the existing substrate.

If the insulation system used is not classed a non-combustible, a non-combustible insulation should be provided around the hot extract flue with a minimum of 100mm cover to each side of the flue and fixed with fire resistant fixings.

**Note:** It is the responsibility of the client / main contractor to assess the existing extract ducts, and extend the flues. Any works to boilers should be carried out by a Gas Safe or Corgi registered engineer

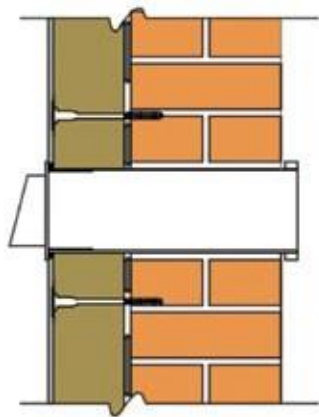

Detail 39 - Cold extract flue

Existing cold extract flues should be extended using a proprietary extension pipe to the depth of the new EWI system. The extension pipe should be secure and fully sealed against the existing substrate.

Where existing balanced flue extract pipes cannot be extended, there should be an allowance to return the insulated render system back into the wall to create a recess, and provide a sill to assist shedding of water.

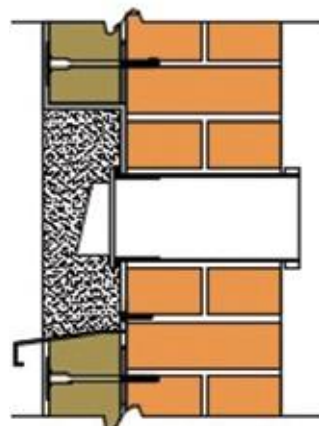

Detail 40 – Un-extended flue

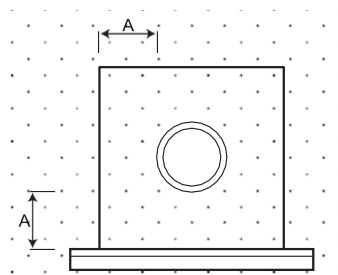

A=300mm if fan flue (condensing boiler) or 600mm if balanced flue (non-condensing boiler)

Refer to HHIC Guidance document on gas appliances.



### Movement Joint Details

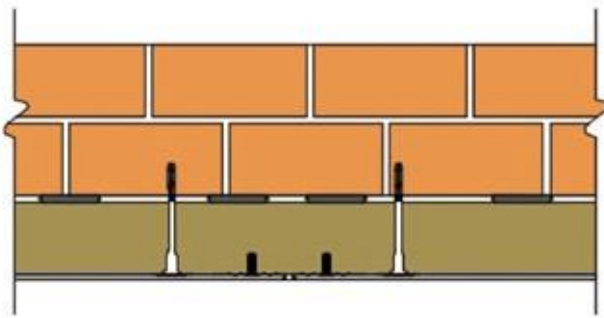

*Detail 41 - Render only movement joint*

Movement joints in cement based render system should be provided at every 6m-8m centres.

Certain systems can be installed with movement joints at greater centres or not required at all, however these systems should be discussed with the system designer.

A render only movement bead should be provided where there can be movement in the board that the render is applied to. Movement beads can be installed using adhesive dabs or fir tree fixings.

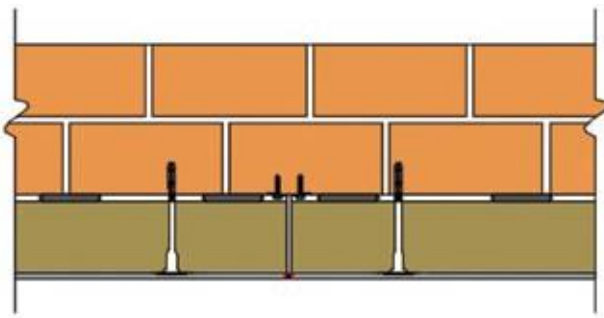

*Detail 42 - Full system movement joint*

Full system movement beads should be provided where the insulation boards used are rigid and do not allow sufficient movement. Full system movement beads should be installed by mechanically securing the bead to the substrate.

It is sometimes a requirement to cut through the insulation behind the movement joint on certain insulation types.

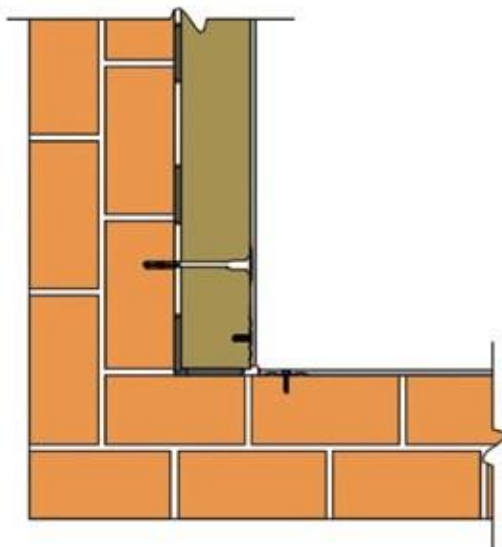

*Detail 43 - Corner movement bead to render only system*

Should the system abut a return wall where a render only system is to be applied, and there is the chance of movement, a proprietary corner expansion bead should be provided.

## 9. Detail Drawings

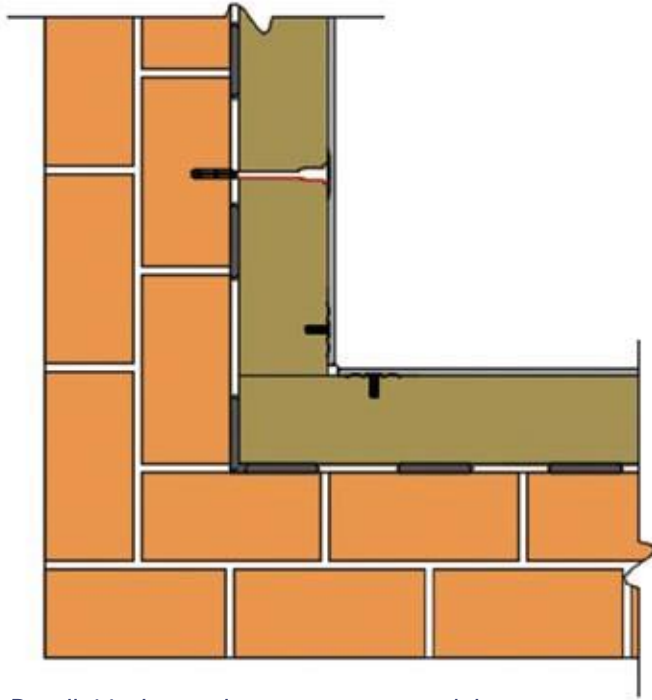

*Detail 44 - Internal corner movement joint*

If there is a concern over movement where the EWI system meets at an internal corner, a proprietary corner expansion bead should be installed using adhesive or fir tree fixings.

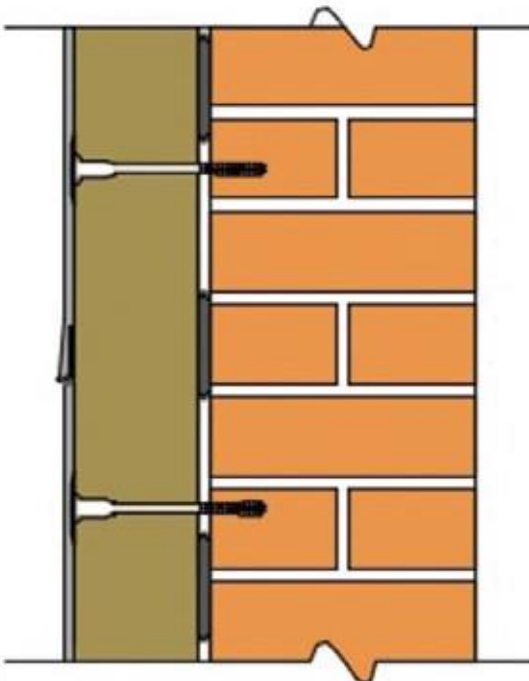

*Detail 45 - Horizontal movement joint*

Horizontal movement joints should be installed and can be provided using a render only drip bead and silicone mastic seal.

For movement joint details the system designer should be contacted for their preferred detail and recommended positions.

### Termination Details

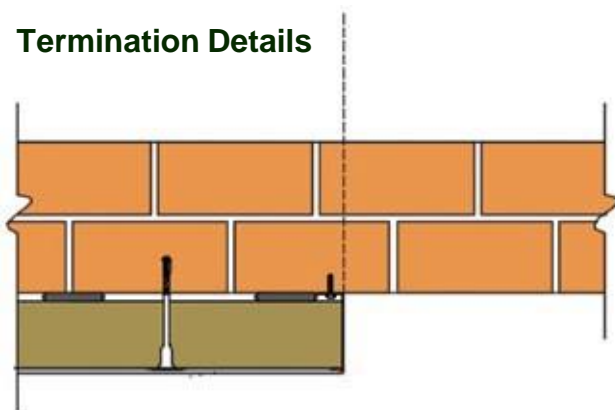

*Detail 46 - Full system stop bead*

Where systems are to be terminated on a party wall line, there can be two acceptable methods.

A full system stop bead can be used, mechanically fixed to the existing substrate and sealed with a silicone mastic sealant.

This detail is used should the adjacent property be clad in the future.

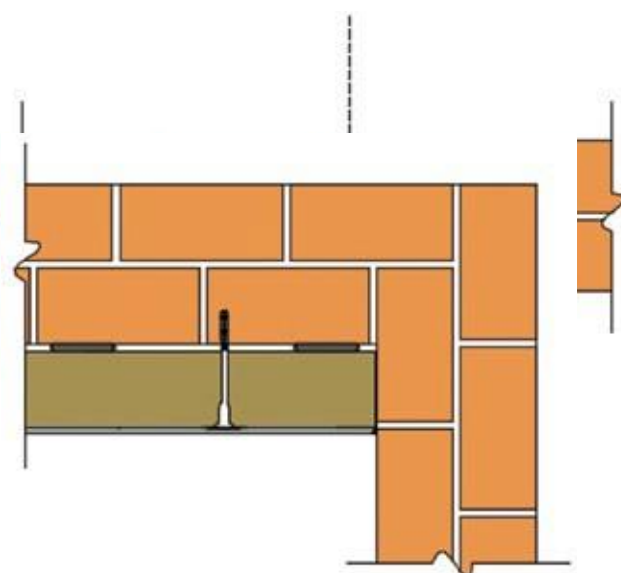

A full render return can be used with the render taken back to the existing substrate and sealed with a silicone mastic sealant.

*Detail 48 - Return at 90 degree un-clad wall*

Where a system abuts a wall at 90 degrees which is not to be clad, then a stop bead and silicone mastic sealant should be used.

## 9. Detail Drawings

### Corner Details

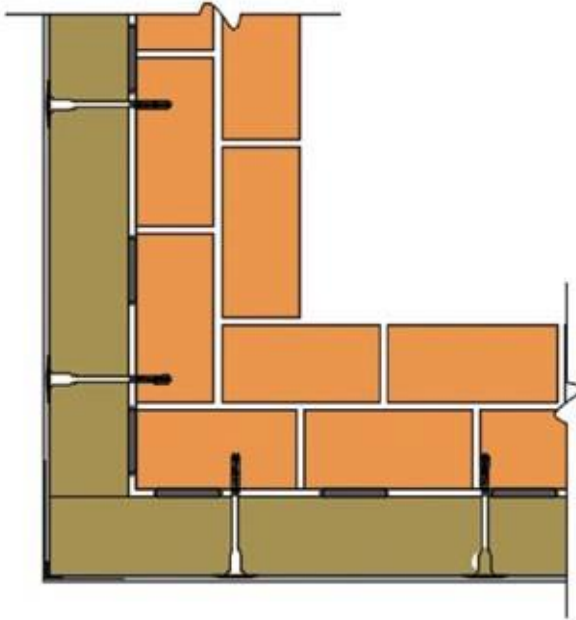

*Detail 49 - Typical external corner*

All corners require a corner bead, lapped with the reinforcing mesh, secured with adhesive or fir tree fixings.

UPVC corner beads can have an integral polypropylene mesh that should overlap the main mesh by a minimum of 100mm.

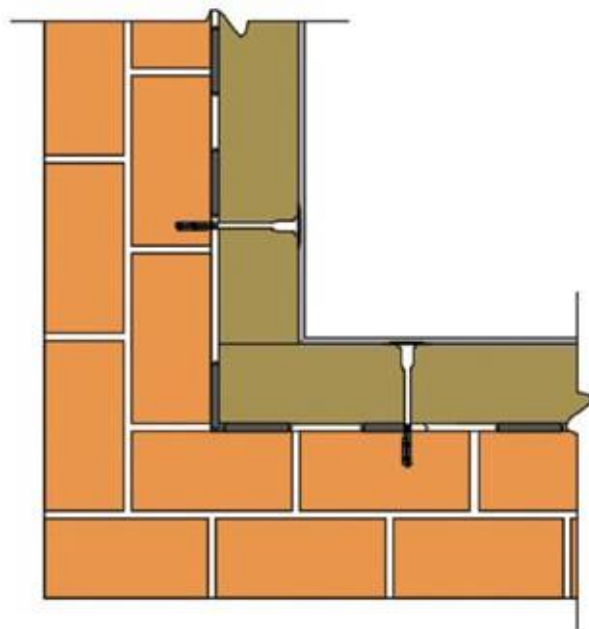

*Detail 50 - Typical external corner*

Where the system is fixed at an internal corner, the system mesh should be lapped around the corner by a minimum of 100mm to ensure continuity of the mesh.

### Adhesive / Dubbing Render

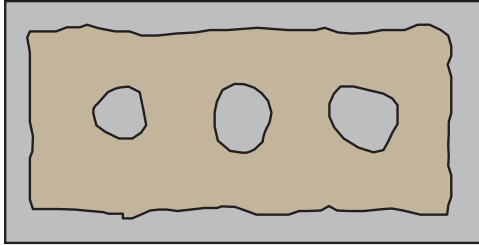

PLAN



SECTION

Adhesively applied systems and dubbing renders can be applied in two ways, and is subject to the advice of the system designer.

Adhesive or dubbing render is applied to the edges of the boards and 3 'dabs' applied to the centre.



ELEVATION

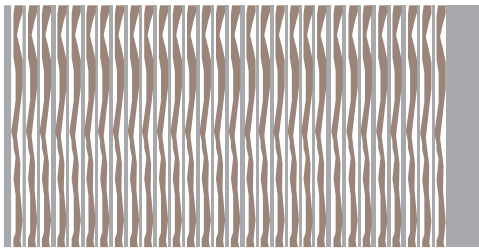

PLAN



SECTION

Adhesive or dubbing render is applied to the entire board with a notched trowel.

The preferred option should be discussed with the system supplier.



ELEVATION

*Detail 51 – Adhesive / dubbing render application*

## 9. Detail Drawings

### Boarding

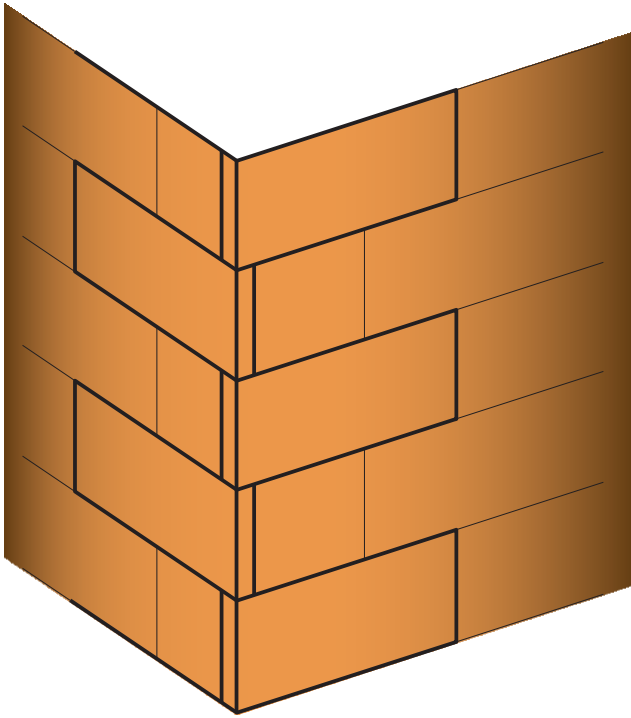

Boards should be installed in a coursed pattern and should be staggered at the corners of buildings in a 'toothed' manner.

*Detail 52 - 3D image on external corner when boarding*

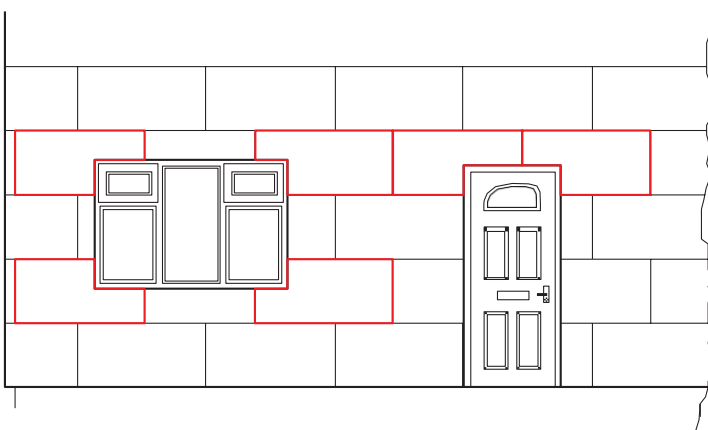

Boards should be cut around existing openings such that they form an L shape. Minimum cuts should be advised by the system supplier, however it is generally recommended at a minimum of 200mm.

*Detail 53 - Elevation on boarding pattern*

## 9. Detail Drawings

### Meshing

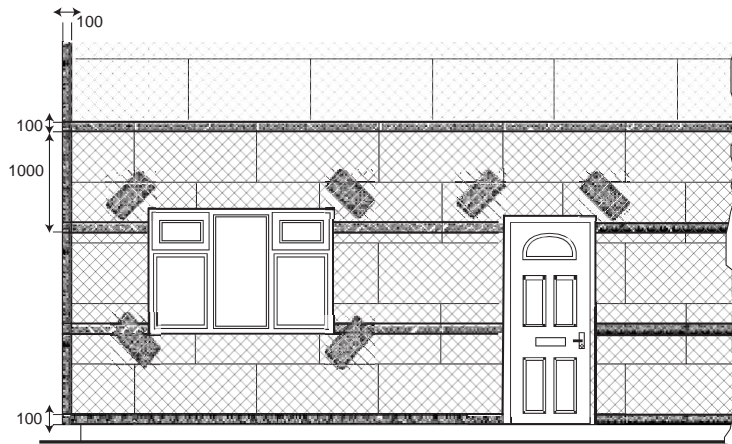

Meshes should over-lap by a minimum of 100mm at all edges and should overlap with integral meshes on the corner beads and starter track clips. Check with system supplier as laps can reduce to 75mm if agreed.

Stress patches should be installed to all corners at openings and should be sized by the system designer.

**Note:** Stress patches should be fitted tight to corners as a rule.

*Detail 54 - Typical meshing and stress patches elevation*

### Wall Abutment Details

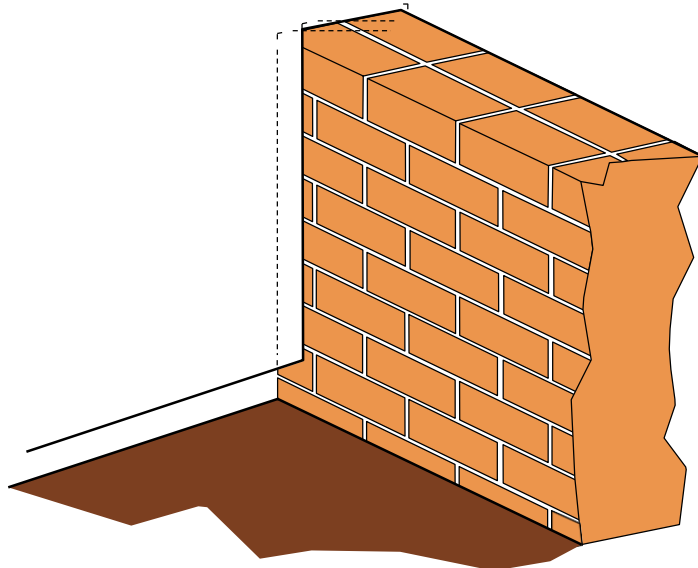

*Detail 55 - 3d image of wall abutment*

Where existing garden wall abut the main house wall, best practice would be to take down the wall locally and allow the installation of the EWI system, with the wall being re-built once the render system has been completed, however timescales do not always allow for this.

Should there be an existing wall built up to the main wall, there should be the introduction of full system stop beads to the edges of the wall, and the joints finished with a hydro-phobic tape and mastic seal.



## 9. Detail Drawings

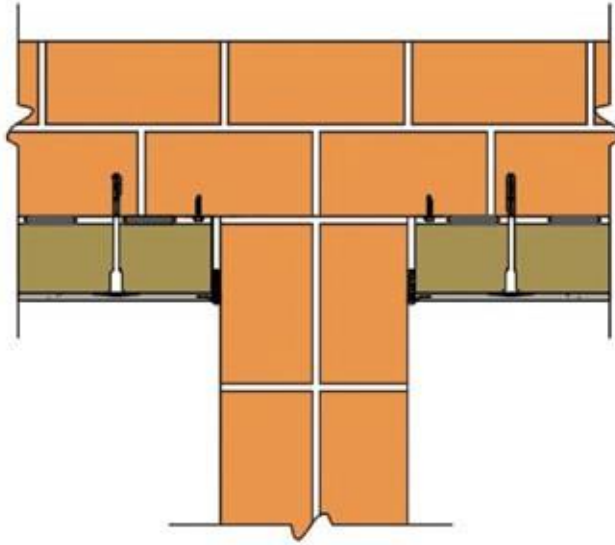

*Detail 56 - Plan on wall abutment*

The system is stopped against full system stop beads and the gaps in filled with a hydrophobic tape and silicone sealant.

The detail indicates the provision for full system stop beads, however should the contractor wish the detail can be finished with surface mounted stop beads or the provision of a suitable mastic seal.

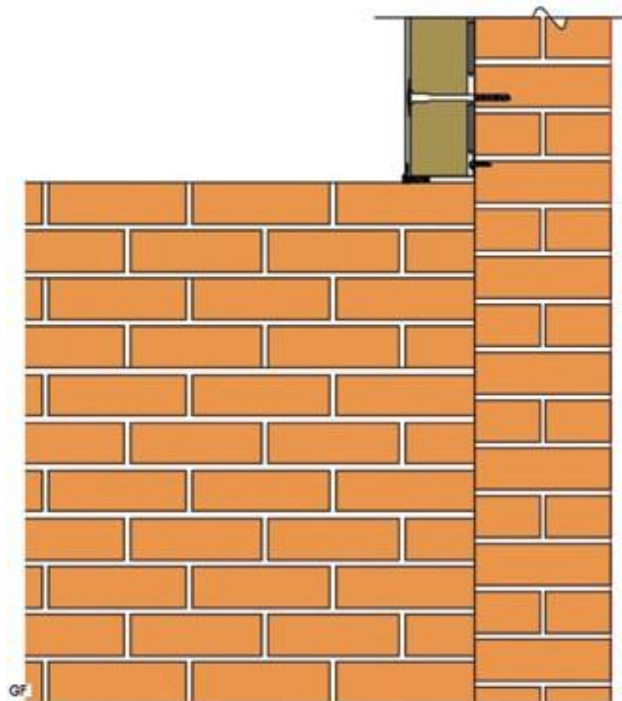

*Detail 57 - Section through abutment wall*

If required, the render can be set 150mm above the wall head, and the render returned. This may assist in avoiding splash back from the wall, however the contractor should agree which option is to be used.

Note:  
A cold bridge  
will occur

### Verge / Junction Detail

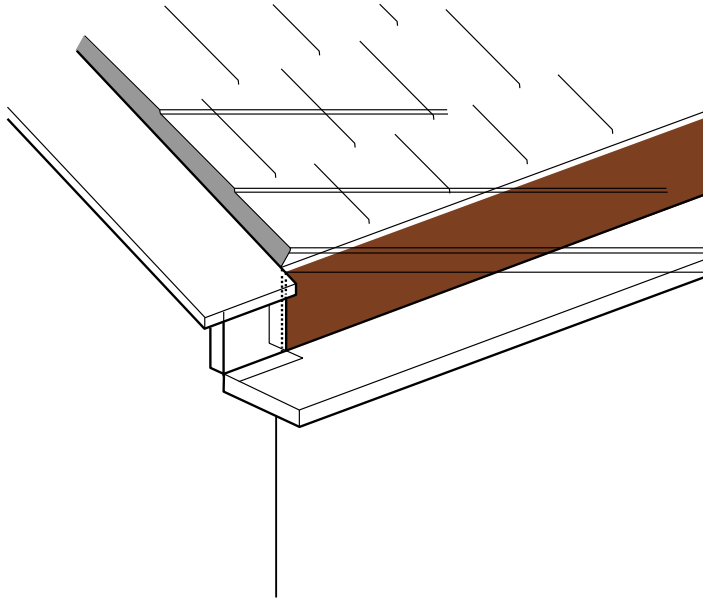

*Detail 58 - Junction between fascia trim and verge trim*

Where a new verge trim and new fascia trim meet, care should be taken to ensure that the end of the insulation and render system is closed.

The new fascia trim should over sail the corner of the new system, and the verge trim should also over sail the new fascia trim.

A section of trim should be cut and fixed to seal the end of the system, and joint sealed with a silicone mastic sealant.

### Verge Trim Connection Details

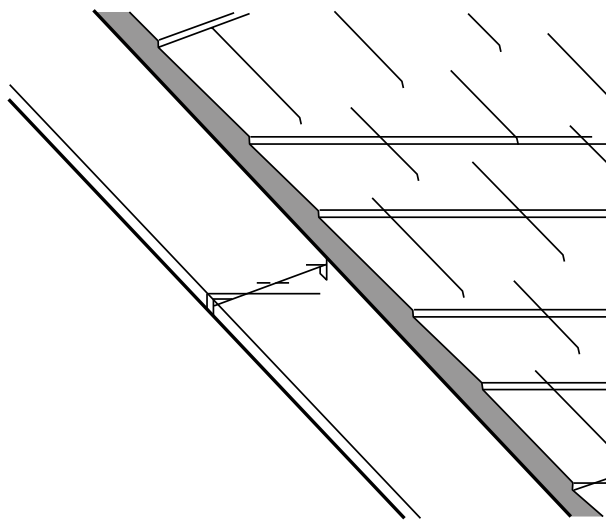

*Detail 59 - 3D image on verge or fascia trim connection profile*

All new verge or fascia trims should be connected with proprietary jointing clips.

These are supplied by the manufacturers of the trims.

Joints should not be jointed or overlapped and sealed with silicone mastic sealant.

## 9. Detail Drawings

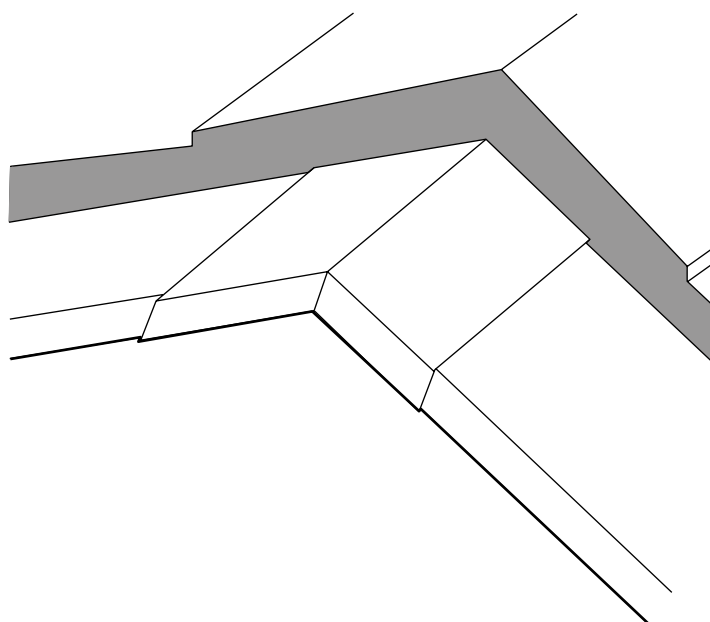

Where verge trims meet at the apex, a proprietary apex closing profile should be used.

The profiles are designed so that they can be bent to suit the pitch of the roof, and should be bedded on a silicone mastic sealant.

The apex profile should be mechanically fixed to the existing substrate.

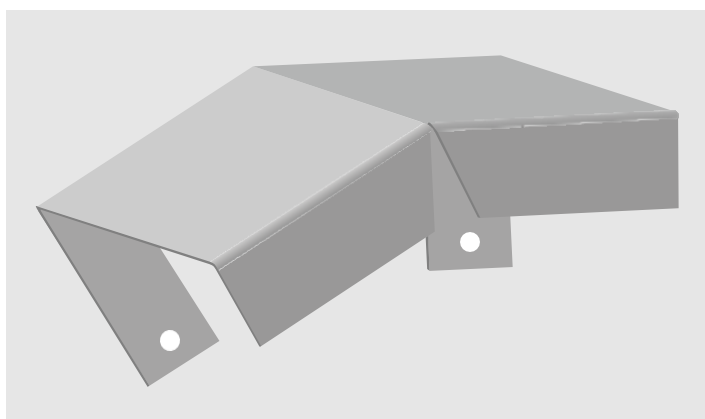

*Detail 60 - Detail on proprietary apex capping profile*

## 9. Detail Drawings

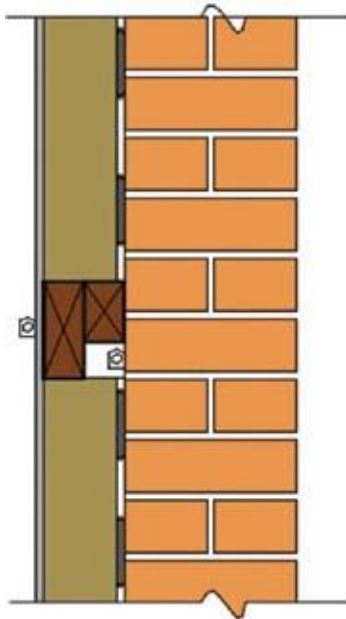

Once discussions with electricity supplier have been undertaken, option to maintain cables on wall, may be agreed, with cables to be disconnected and then new cables installed once works are completed.

Install double timber pattress to protect existing cables and provide grounds for new cable.

*Detail 61 – Power cable temporarily covered by system*

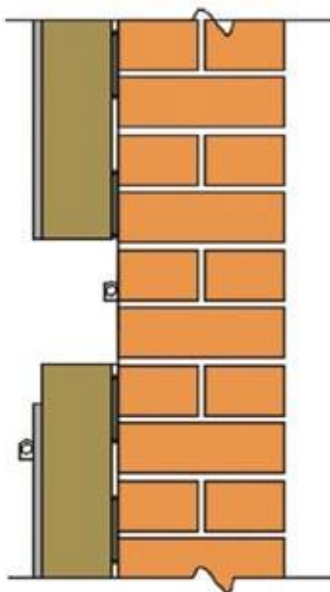

*Step 1*

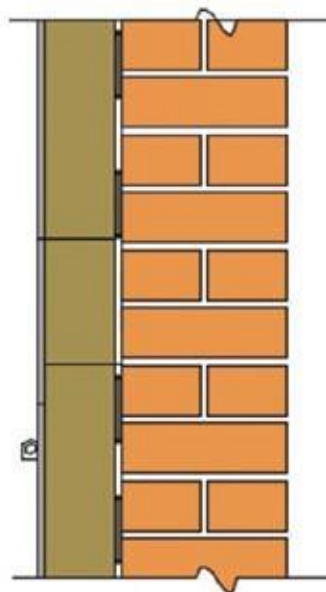

*Step 2*

*Detail 62 – Power cable relocated during works*

If the agreed detail is to relocate the cable during the works, the system should be installed with a trough carefully measured to minimise patching effect. The render system should be left short of the insulation board. The cable should be removed / un-clipped from the wall and relocated to the outside of the new system. The gap in the system should be filled with insulation, and the rendered finish lapped with the existing installed system, and the finishes applied.

This detail can be accommodated with dash and brick effect render finishes, however textured finish should be carefully applied to avoid the patch being obvious, however any patch may be seen in the final finish.

## 9. Detail Drawings

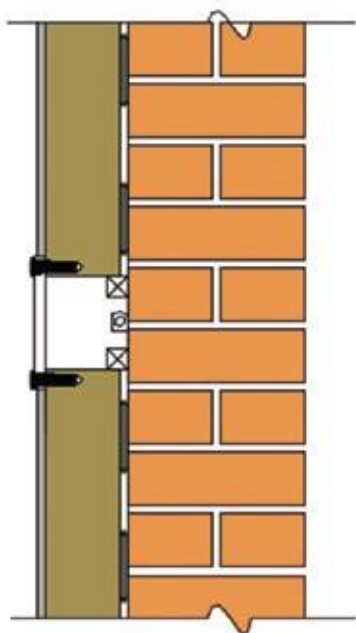

Where the cable is to be maintained, an allowance for a ventilated cover plate should be made.

Allow for 25mm cover from the cable.

*Detail 63 – Cable maintained*

# 10. Summary

This document has been produced as a reference tool to establish a baseline for best practice when assessing and installing EWI systems for the refurbishment of existing housing stock.

The installation of EWI should be undertaken where the detailing carried out is both technically and feasibly achievable, however this should not be used as an excuse for poor detailing both on paper and on site.

The installation of EWI, if undertaken correctly, will enhance both the thermal and aesthetic properties of an existing building, with the system lasting for the life time guaranteed by the designer. Poor installation of systems, can have the opposite effect, and can in many cases lead to issues such as mould growth through cold bridges, water ingress, and a poor appearance.

The guidance contained within this document, aims to assist site detailing, and provide a commonality between systems, to reduce the variation in detailing observed on many building sites where EWI system are being installed.

# 11. References

- British Board of Agrément (BBA), Installer Approval (online) [www.bbacerts.co.uk/installer-approval](http://www.bbacerts.co.uk/installer-approval)
- BS EN 13914-1:2005 Part 1: External Renderings
- BS EN 998-1-2010: Specification for Rendering and Plastering Mortars
- European Organisation for Technical Approvals (EOTA)
- INCA Technical Guide 03 – Wind Load Design Considerations for EWI Systems <http://www.inca-ltd.org.uk/documents/INCATechnicalGuide03-WindLoadDesignConsiderationsforEWISystems.pdf>
- Local Authority Building Control Approval (LABC)
- National House Building Council (NHBC) Technical Standards, 2011. Chapter 1.2 - A consistent approach to finishes
- Northern Ireland Technical Standards
- Scottish Building Standards
- The Building Regulations, England and Wales 2010-2013 Editions
- UK Government Planning Portal [www.planningportal.gov.uk](http://www.planningportal.gov.uk)







**Insulated Render and Cladding Association**

**INCA**

**t:** 0330 124 6585

**e:** [info@inca-ltd.org.uk](mailto:info@inca-ltd.org.uk) **w:** [www.inca-ltd.org.uk](http://www.inca-ltd.org.uk)

